

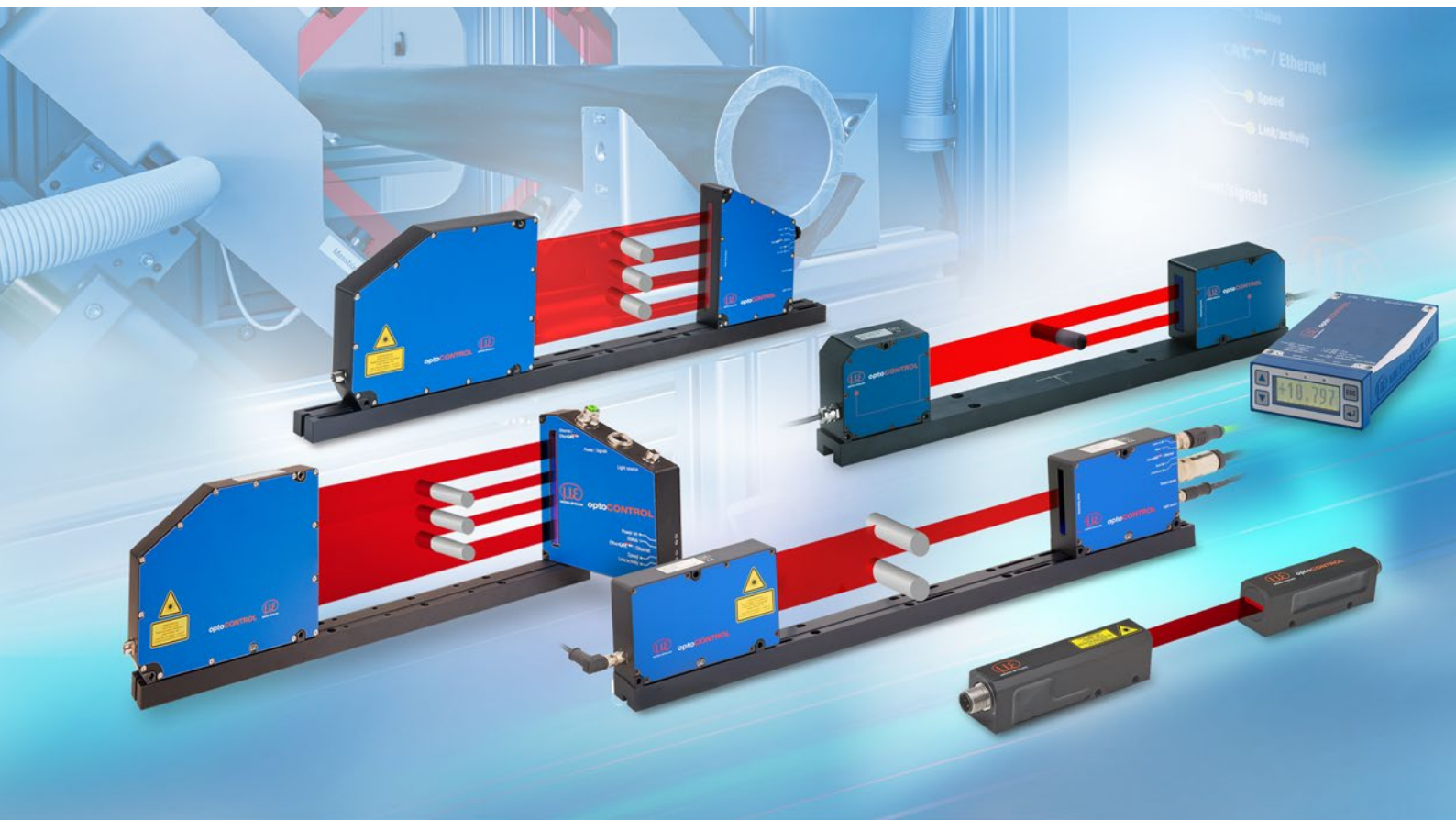







# More Precision

**optoCONTROL** // Optical precision micrometers



# Precise laser micrometer with integrated controller

## optoCONTROL 2520-46

-  Measuring range 46 mm
-  Measurement distances up to 2 m
-  Linearity  $\pm 12 \mu\text{m}$
- INTER FACE** Ethernet / EtherCAT / RS422 / Analog / EtherNet/IP / PROFINET
-  Laser class 1M
-  Configurable via web interface

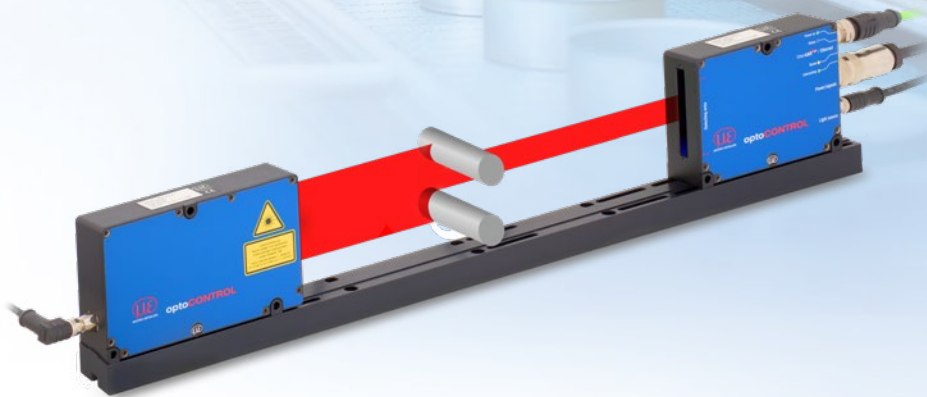

optoCONTROL 2520-46 is a compact laser micrometer which is characterized by high accuracy with a large measuring range of 46 mm. The optoCONTROL 2520 is flexible; the measuring object can be placed at any position within the light curtain and the distance from the light source to the receiver can be freely selected. The smallest detectable target diameter is 0.5 mm, which allows for example PINs and small gaps to be detected. The optoCONTROL 2520 is also used for counting tasks and roundness measurements.

### Measurement modes

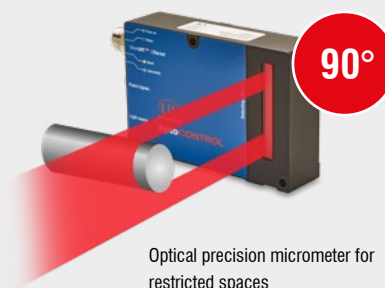
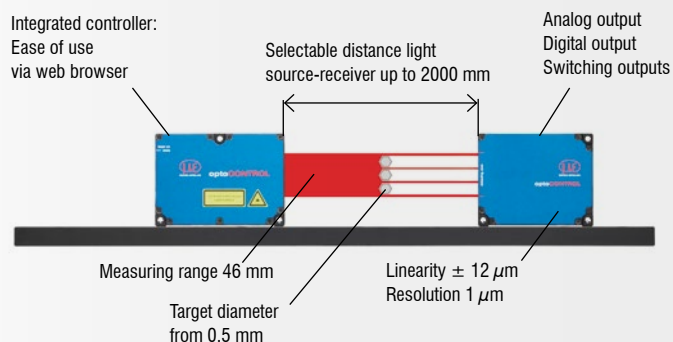
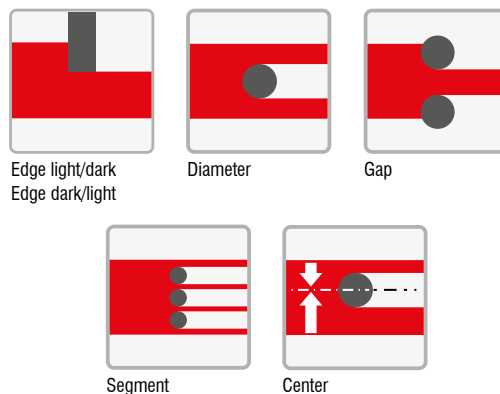

Model	ODC 2520-46	ODC 2520-46(090) angled at 90°
Measuring range	46 mm	
Min. target size	typ. $\geq 0.5$ mm	
Distance light source - receiver (free space)	with mounting rail 100 ... 300 mm; without mounting rail open to approx. 2000 m	
Measuring distance (target - receiver)	20 mm ... 2000 mm; optimum distances: 20, 50, 100, 150 mm	
Measuring rate	2.5 kHz	
Resolution <sup>1)</sup>	1 $\mu$ m	
Linearity <sup>2)</sup>	$< \pm 12 \mu$ m	
Repeatability <sup>3)</sup>	$\leq 5 \mu$ m	
Light source	Semiconductor laser 670 nm (red)	
Laser class	Laser class 1M ( $P_{max}$ 2 mW) according to DIN EN 60825-1 : 2015-07	
Permissible ambient light	approx. 20,000 lx	
Analog output	0 ... 10 V not electrically separated, 14-bit D/A	
Digital interface	RS422 (max. 4 MBaud), full duplex, not electrically separated / Ethernet, electrically separated / EtherCAT / EtherNet/IP <sup>4)</sup> / PROFINET <sup>4)</sup>	
Switching output	2 outputs, optionally for errors or limits, not electrically separated / 24 V logic (HTL), High level depends on supply voltage	
Signal input	Zero setting/mastering, resetting to factory defaults; not electrically separated, 24 V logic (HTL) High level depends on supply voltage; TrigIn / SyncIn via RS422 level	
Digital output	SyncOut symmetric, RS422 level, terminating resistance (120 ohm) direction can be switched via software, not electrically separated	
Connection	Receiver	3-pin socket M8 for supply of light source; 14-pin M16 socket for power supply & signals, 4-pin M12x1 socket for Ethernet / EtherCAT
	Light source	3-pin socket M8 for supply
Mounting	Mounting rail (see accessories), mounting holes	
Temperature range	Storage	-20 ... +70 °C
	Operation	0 ... +50 °C
Supply voltage	+24 VDC (11 ... 30 VDC)	
Maximum power consumption	$< 1$ A	
Shock (DIN EN 60068-2-27)	15 g / 6 ms	
Vibration (DIN EN 60068-2-6)	2 g / 20 ... 500 Hz	
Protection class (DIN EN 60529)	Receiver / light source	IP64
Material	Receiver / light source	Aluminum housing
Weight	1.25 kg (without cable)	
Measuring programs	Edge light-dark; edge dark-light (outside) diameter / width incl. edges & center axis gap / (inside diameter) incl. edges & center axis any segments, incl. segment edges & center axes	
Control and indicator elements	Web interface for setting parameters and display; color LEDs for Power on, Status, Speed, Link/activity	
Special features	Integrated web server for transmission of several measurements to the PC; optional other periphery devices, see operating instructions	

The specified data apply for a consistent room temperature of 20 °C, continuously in operation, signal outputs open and sensor mounted on included mounting rail  
Measured at light source - receiver distance of 300 mm, measured object - receiver distance of 20 mm, operating mode: edge light-dark

<sup>1)</sup> At the digital interface

<sup>2)</sup> Measured with 3 sigma

<sup>3)</sup> Measured with a moving average over 32 values

<sup>4)</sup> Connection via interface module (see accessories)

# Precise laser micrometer with integrated controller

## optoCONTROL 2520-46

optoCONTROL 2520-46

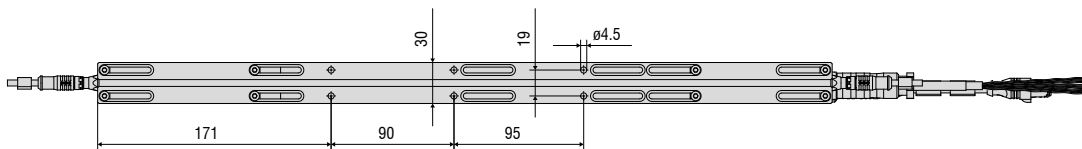
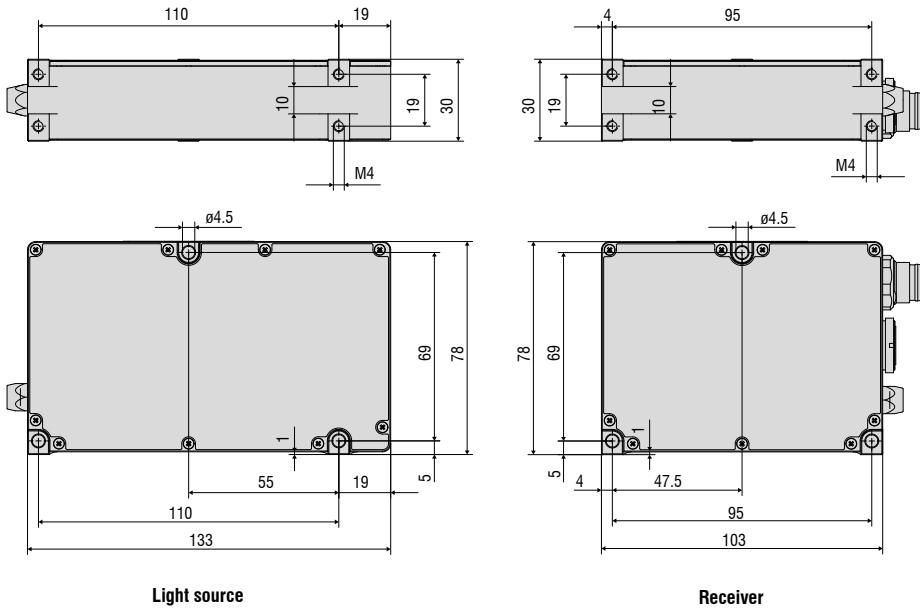

**Light source and receiver with mounting rail**

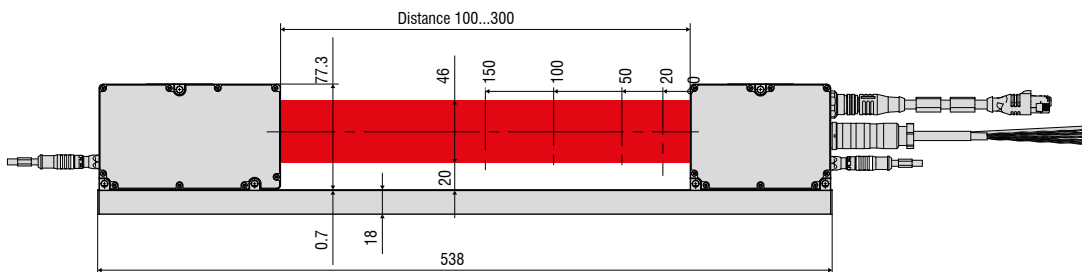

optoCONTROL 2520-46(090), 90° angle

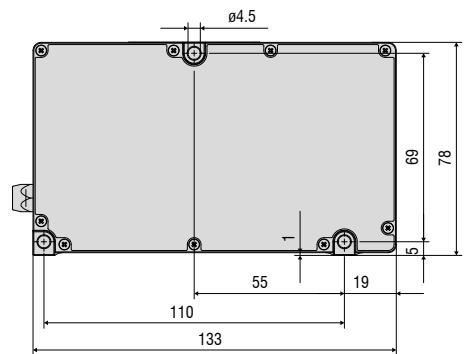
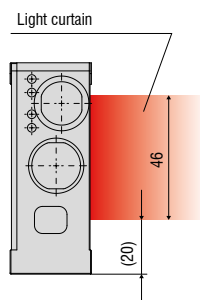
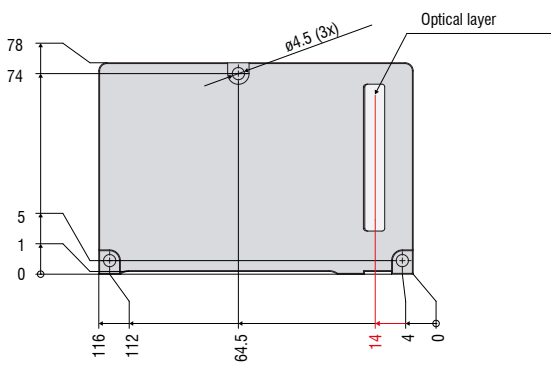
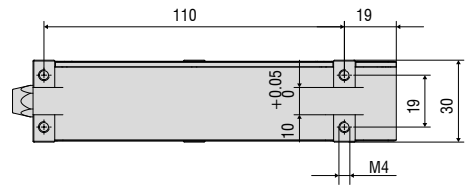
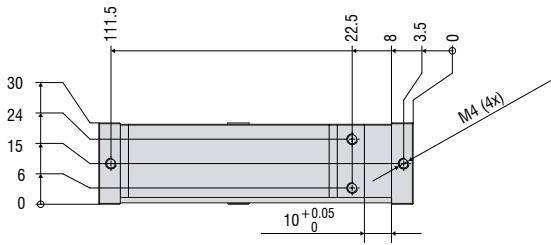

Light source

Receiver

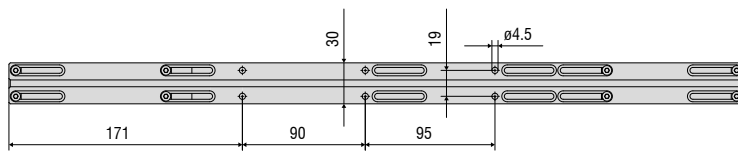



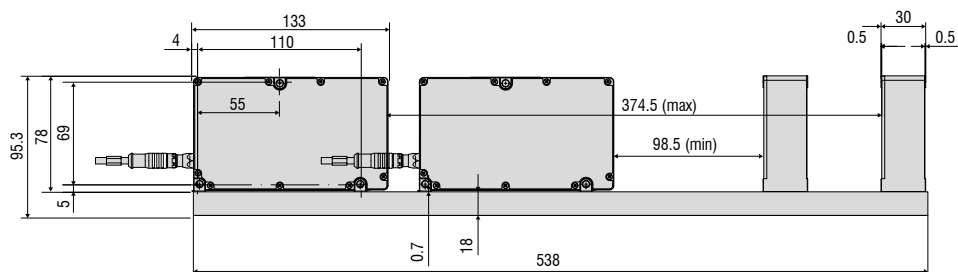

Light source and receiver with mounting rail



# Precise laser micrometer with large measuring range

## optoCONTROL 2520-95

-  Measuring range 95 mm
-  Measurement distances up to 2 m
-  Linearity  $\pm 15 \mu\text{m}$
- INTER FACE** Ethernet / EtherCAT / RS422 / Analog / EtherNet/IP / PROFINET
-  Laser class 1M
-  Configurable via web interface

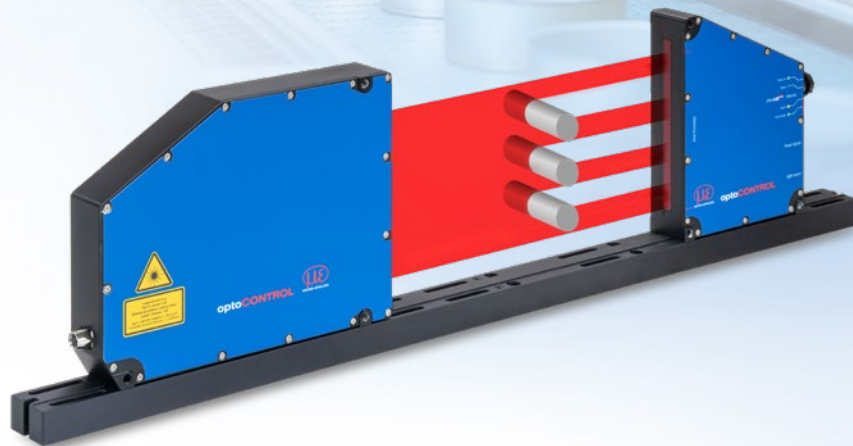

The optoCONTROL 2520-95 is a compact laser micrometer that features excellent linearity and high accuracy with a large measuring range of 95 mm. The optoCONTROL 2520-95 is flexible; the measuring object can be placed at any position within the light curtain and the distance from the light source to the receiver can be freely selected.

The precise measurement results can be output at a measuring rate up to 2000 values per second. Moreover, the powerful micrometer also enables the simultaneous measurement of up to 8 segments and the synchronous output of several measurement values.

Depending on the installation scenario and the available installation space, the angled variant (270°) can reduce the required space.

### Measurement modes

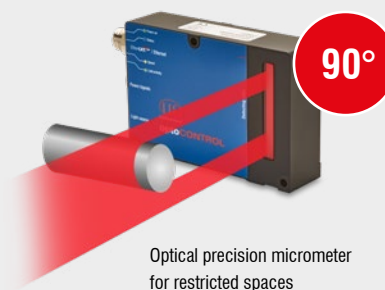
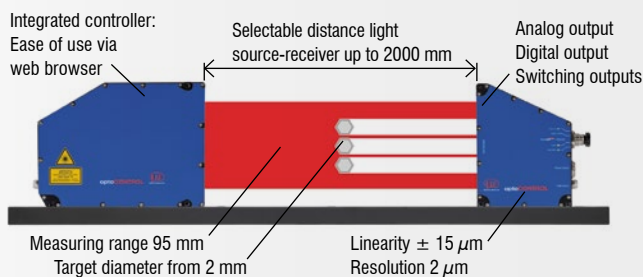
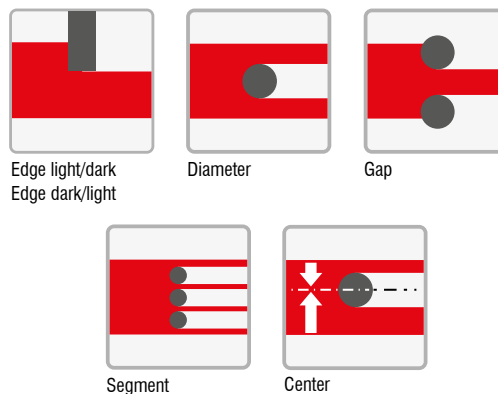

Model	ODC 2520-95	ODC 2520-95(270) angled at 90°
Measuring range	95 mm	
Min. target size	typ. $\geq 2.0$ mm / $100 \mu\text{m}$ <sup>4)</sup>	
Distance light source - receiver (free space)	with mounting rail 100 ... 300 mm; without mounting rail open to approx. 2000 m	
Measuring distance (target - receiver)	20 mm ... 2000 mm; optimum distances: 20, 50, 100, 150 mm	
Measuring rate	2.0 kHz	
Resolution <sup>1)</sup>	2 $\mu\text{m}$	
Linearity <sup>2)</sup>	< $\pm 15 \mu\text{m}$	< $\pm 20 \mu\text{m}$
Repeatability <sup>3)</sup>	$\leq 6 \mu\text{m}$	
Light source	Semiconductor laser 670 nm (red)	
Laser class	Laser class 1M (P <sub>max</sub> 2 mW) according to DIN EN 60825-1 : 2015-07	
Permissible ambient light	approx. 15,000 lx	
Analog output	0 ... 10 V not electrically separated, 14-bit D/A	
Digital interface	RS422 (max. 4 MBaud), full duplex, not electrically separated Ethernet, electrically separated / EtherCAT / EtherNet/IP <sup>5)</sup> / PROFINET <sup>5)</sup>	
Switching output	2 outputs, optionally for errors or limits, not electrically separated / 24 V logic (HTL), High level depends on supply voltage.	
Signal input	Zero setting/mastering, resetting to factory defaults; not electrically separated, 24 V logic (HTL) High level depends on supply voltage; TriglN / SynclN via RS422 level	
Digital output	SyncOut symmetrical, RS422 level, terminating resistor (120 ohm) direction can be switched using software, not electrically separated	
Connection	Receiver	3-pin socket M8 for supply of light source; 14-pin M16 socket for power supply & signals, 4-pin M12x1 socket for Ethernet / EtherCAT
	Light source	3-pin socket M8 for supply
Mounting	Mounting rail (see accessories), mounting holes	
Temperature range	Storage	-20 ... +70 °C
	Operation	0 ... +50 °C
Supply voltage	+24 VDC (11 ... 30 VDC)	
Maximum power consumption	< 1A	
Shock (DIN EN 60068-2-27)	6 g / 6 ms in 3 axes, 1000 shocks each	
Vibration (DIN EN 60068-2-6)	2 g / 10 ... 500 Hz in 3 axes, 10 cycles each	
Protection class (DIN EN 60529)	Receiver / light source	IP64
Material	Receiver / light source	Aluminum housing
Weight	2.0 kg (without cable)	
Measuring programs	Edge light-dark; edge dark-light; (outside) diameter / width incl. edges & center axis gap / (inside diameter) incl. edges & center axis; any segments, incl. segment edges & center axes	
Control and indicator elements	Web interface for setting parameters and display; color LEDs for Power on, Status, Speed, Link/activity	
Special features	Integrated web server for transmission of several measurements to the PC; optional other periphery devices, see operating instructions	

The specified data apply for a consistent room temperature of 20 °C, continuously in operation, signal outputs open and sensor mounted on included mounting rail.

Measured at light source - receiver distance of 300 mm, measured object - receiver distance of 20 mm, operating mode: edge light-dark

<sup>1)</sup> At the digital interface

<sup>2)</sup> Measured with 3 sigma

<sup>3)</sup> Measured with a moving average over 32 values

<sup>4)</sup> Smallest detectable object, not measurable

<sup>5)</sup> Connection via interface module (see accessories)

# Precise laser micrometer with large measuring range

## optoCONTROL 2520-95

### optoCONTROL 2520-95

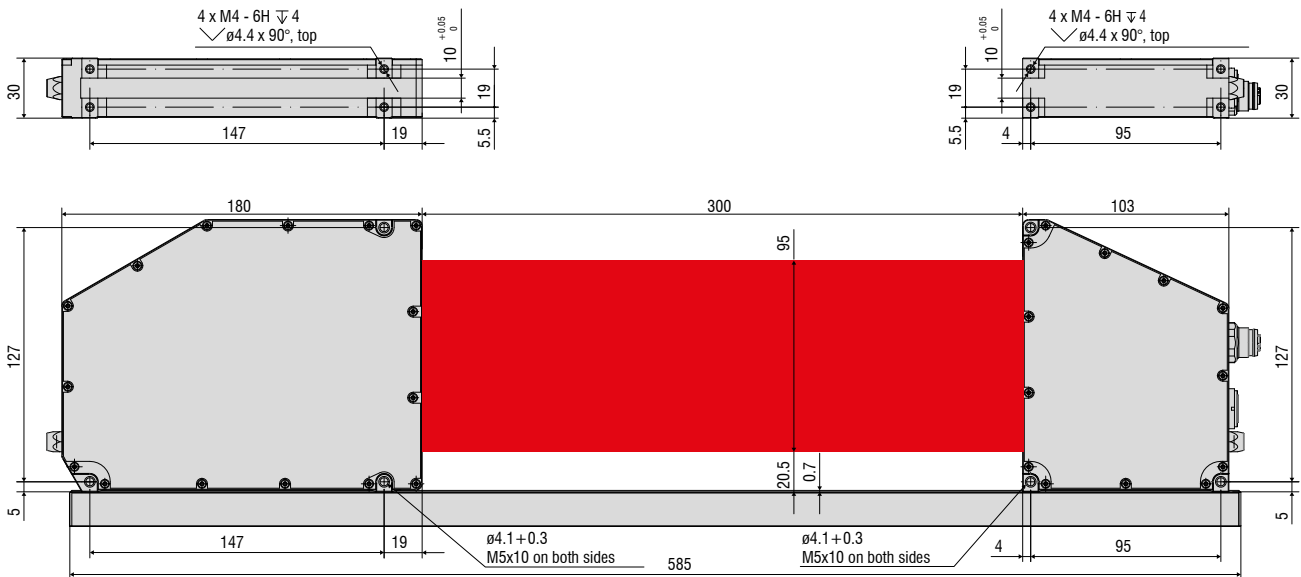

Light source

Receiver

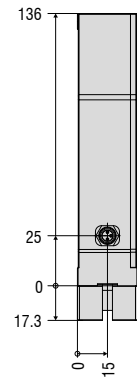
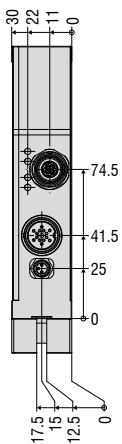
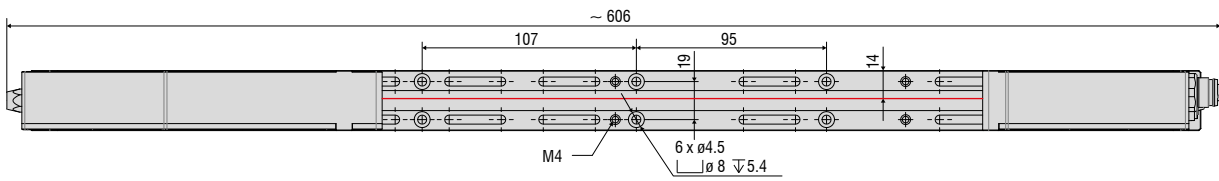



optoCONTROL 2520-95(270), 90° angle

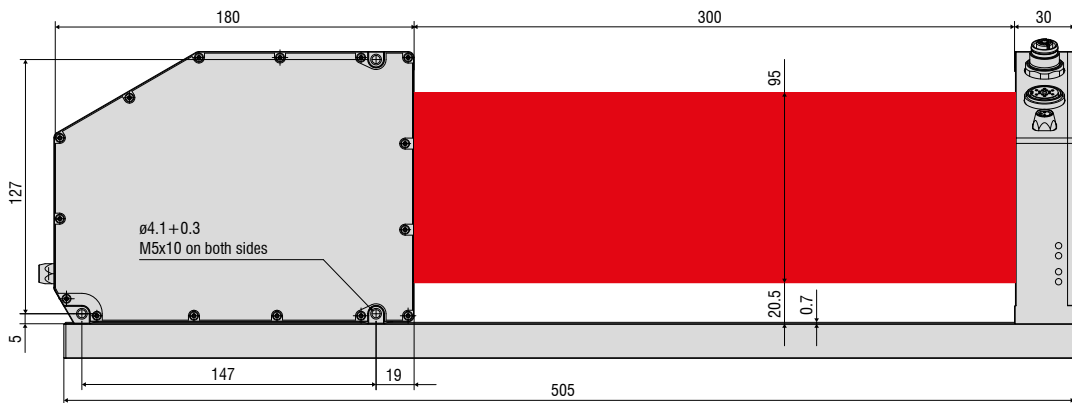

Light source

Receiver

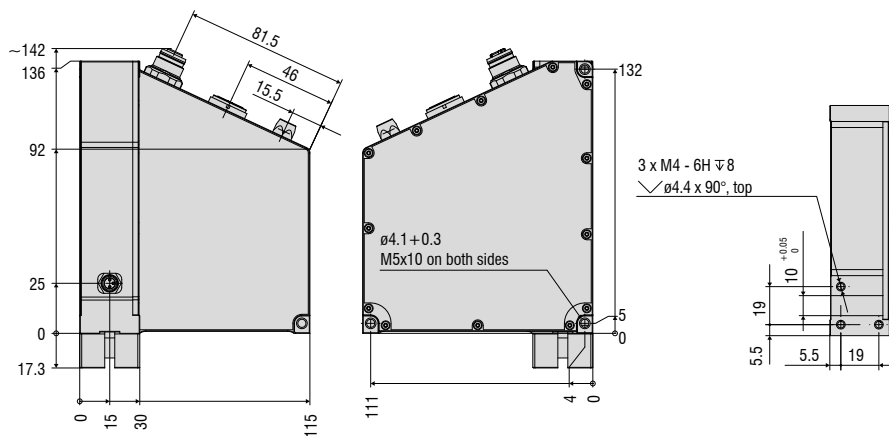
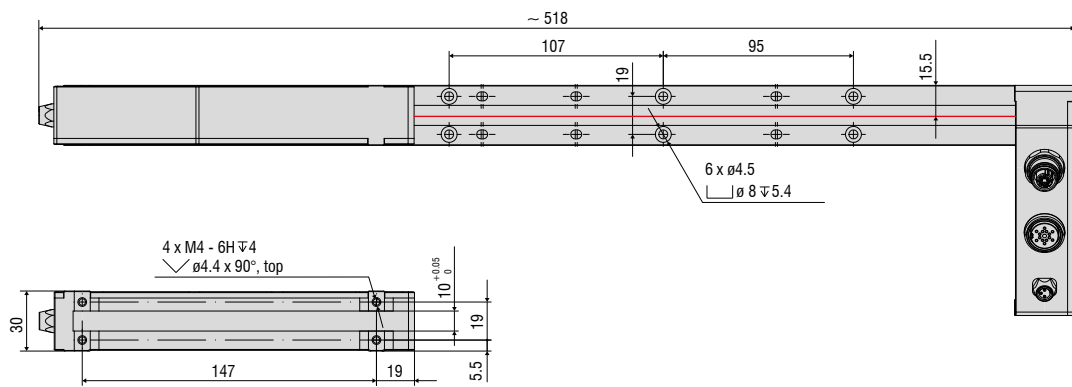

# Interface modules and accessories

## optoCONTROL

### XFrame2520 for 2-axis measurements

Accessory for the integration of optical ODC2520-46 micrometers for diameter measurements

- 2-axis frame for X-arrangement of 2 sensors
- Optics can be cleaned with compressed air
- e.g. for wires, cables, tubes, rods or flat steel
- Objects up to 46 mm diameter measurable
- Measuring range 46 x 46 mm
- Evaluation of the two sensors via universal controller possible (not included in scope of delivery)



### Various ODC tools for ODC2520 and ODC2600

Depending on the sensor, diverse tools for continuous measurement value recording and parameter set up are available free of charge

- ODC2600 & ODC2500 Tool: For parameterization and continuous recording of measured values.
- SensorTOOL: The measured values of one or more micrometers can be graphically displayed and recorded simultaneously.



### Interface modules

Module	ODC1200	ODC2520	ODC2600
<b>IF2001/USB</b> RS422/USB converter to transform a digital signal to USB	⊘	✓	✓
<b>IC2001/USB</b> Single-channel RS422/USB converter cable	⊘	✓	✓
<b>IF2004/USB</b> RS422/USB converter to convert up to 4 digital signals to USB	⊘	✓	✓
<b>IF2008/ETH</b> Interface module for Ethernet connection for up to 8 sensors	⊘	✓	⊘
<b>IF2008PCIE</b> Interface card for multiple sensor signals; analog and digital interfaces	✓	✓	✓
<b>IF2035-EtherCAT</b> Interface module for Industrial Ethernet connection (EtherCAT)	⊘	✓	⊘
<b>IF2035/PROFINET</b> Interface module for Industrial Ethernet connection (PROFINET)	⊘	✓	⊘
<b>IF2035/EtherNetIP</b> Interface module for Industrial Ethernet connection (EtherNet/IP)	⊘	✓	⊘
<b>IF1032/ETH</b> Interface module for connecting the analog interface to Ethernet or Industrial Ethernet (EtherCAT)	✓	⊘	⊘

### IF2001/USB converter RS422 to USB

The RS422/USB converter converts the digital signals of an optical micrometer into a USB data packet. The sensor and the converter are connected via the RS422 interface of the converter. Data output is done via USB interface. The converter loops through further signals and functions such as laser on/off, switch signals and function output. The connected sensors and the converter can be programmed through software.

#### Special features

- Robust aluminum housing
- Easy sensor connection via screw terminals (plug and play)
- Conversion from RS422 to USB
- Supports baud rates from 9.6 kBaud to 12 MBaud

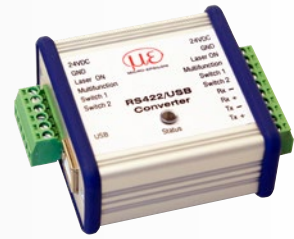

### IC2001/USB Single-channel converter cable RS422/USB

The IC2001/USB single-channel converter cable is used for the USB connection of optoCONTROL sensors equipped with an RS422 interface. The cable is easy to assemble and can therefore also be used for installation in machines and systems.

#### Special features

- 5-core interface cable without outer shield
- Conversion from RS422 to USB
- Easy sensor connection via USB
- Supports baud rates from 9.6 kBaud to 1 MBaud



### IF2004/USB: 4-channel converter from RS422 to USB

The RS422/USB converter is used for transforming digital signals from up to four precision micrometers into USB data signals. The converter has four trigger inputs and a trigger output for connecting additional converters. Data is output via an USB interface. The connected sensors and the converter can be programmed through software. The COM interfaces can be used individually and can be switched.

#### Special features

- 4x digital signals via RS422
- 4x trigger inputs, 1x trigger output
- Synchronous data acquisition
- Data output via USB

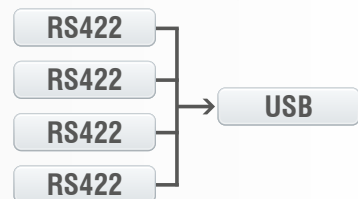

### IF2008/ETH

#### IF2008/ETH Interface module for Ethernet connection with up to 8 sensors

The IF2008/ETH integrates up to eight sensors and/or encoders with an RS422 interface into an Ethernet network. Four programmable switching in-/outputs (TTL and HTL logic) are available.

Ten indicator LEDs directly on the module show both the channel and the device status. In addition, acquisition and output of data via Ethernet is in addition performed at high speeds up to 200 kHz. Parameter setting of the interface module can be easily done via the web interface.



# Interface modules and accessories

## optoCONTROL

### IF2008PCIe/IF2008E

#### Interface card for synchronous data acquisition

Absolute synchronous data acquisition is a decisive factor for the deflection or straightness measurement using several laser sensors. The IF2008PCIe interface card is designed for installation in PCs and enables the synchronous capture of four digital sensor signals and two encoders. The data is stored in a FIFO memory in order to enable resource-saving processing in blocks in the PC. The IF2008E expansion board enables to detect in addition two digital sensor signals, two analog sensor signals and eight I/O signals.

#### Special features

- IF2008PCIe - Basic printed circuit board: 4 digital signals and 2 encoders
- IF2008E - Expansion board: 2x digital signals, 2x analog signals and 8x I/O signals

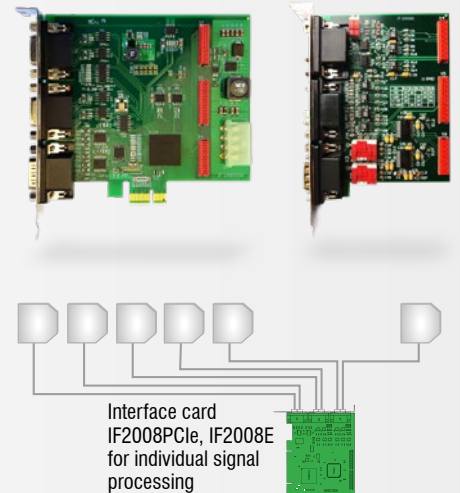

### IF2035

#### Interface module for Industrial Ethernet connection

The IF2035 interface modules are designed for easy connection of Micro-Epsilon sensors to Ethernet-based fieldbuses. The IF2035 is compatible with sensors that output data via an RS422 or RS485 interface and supports the common Industrial Ethernet protocols EtherCAT, PROFINET and EtherNet/IP.

These modules operate on the sensor side with up to 4 MBd and have two network connections for different network topologies. In addition, the IF2035-EtherCAT offers a 4-fold oversampling function, which enables faster measurements than the bus cycle allows, if required. Installation in control cabinets is via a DIN rail.

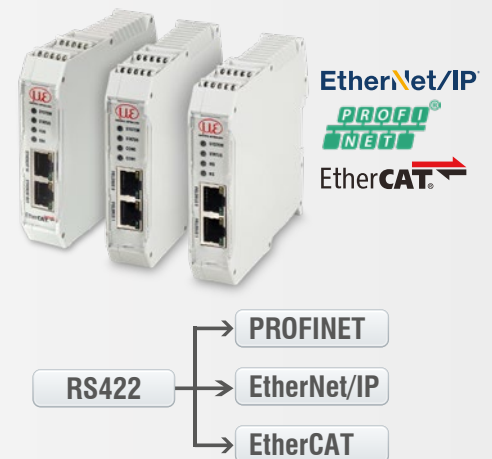

### IF1032/ETH







The IF1032/ETH interface module now enables to run micrometers equipped with analog interfaces with the proven operating concept based on a web interface. The Ethernet interface permits to easily display the measured data on a PC. Moreover, micrometers can be connected to an EtherCAT bus. The RS485 interface allows to connect new micrometers that use the Micro-Epsilon specific RS485 protocol.

#### Interfaces













- Ethernet/EtherCAT
- 1x RS485 (ME-internal protocol)
- 2x analog-in (14 bit, max. 4 ksps), voltage
- 1x analog-in, (14 bit, max. 4 ksps), current
- Inputs for supply voltage
- Trigger input
- EtherCAT synchronization output
- Output for sensor power supply



# optoCONTROL 1200/1201

Connection	Interface modules	Connection cables	Mounting	Accessories
<b>Power supply</b> Power supply unit PS2031 2420096  Power supply unit PS2020 2420062		<b>Power supply and signal cables</b> PC1200/90-5 (5 m) (90°) 2901261  PC1200-5 (5 m) 2901260  PC1200-10 (10 m) 2901483		<b>Adjustment plate</b> <u>Receiver</u> JU1200-HR (horizontal) 2966018 JU1200-VR (vertical) 2966019  <u>Transmitter</u> JU1200-VT (vertical) 2966020 JU1200-HT (horizontal) 2966021
<b>Digital output / Ethernet / EtherCAT</b>  	IF1032/ETH 2420066 max. 4 kSps  			  (for 1200 and 1200/90)
<b>PLC Analog</b> Connection via 0 ... 10 V  	Direct 0 - 10 VDC		<b>Mounting rail for C-frame mounting</b>  ODC1202-L100 (L=0.4 m) 2966006 ODC1202-L200 (L=0.5 m) 2966007 ODC1202-L500 (L=0.8 m) 2966008    (for 1200 and 1200/90)	<b>Bracket for C-frame mounting</b>  BR1200L220 (L=220 mm) 2966024  BR1200L320 (L=320 mm) 2966025





















# optoCONTROL 2600

Connection	Interface modules	Connection cables	Mounting	Accessories
<b>Power supply</b> Power supply unit PS2031 2420096  Power supply unit PS2020 2420062		<b>Supply cables (open)</b> PC2500-3 (3 m) 2901123 PC2500-10 (10 m) 2901124		<b>Demo prism</b> incl. testing pins 9335380  
<b>Serial or analog connection to PC or PLC</b>  	Direct 0 - 10 VDC  Direct RS232 SUB-D9  Direct RS422 SUB-D9  Direct RS422 OE	<b>Output cables IO analog</b> SCA2500-3 (3 m analog) 2901120 SCA2500-10 (10 m analog) 2901215  <b>Signal output cables serial RSxxx</b> SCD2500-3/3/RS232 (3 m) 2901121 (analog + signals / 3 m RS232) SCD2500-3/10/RS422 (3 m) 2901122 (analog + signals / 10 m RS422) SCD2500-3/RS422 2901111 (3 m only RS422 open ends)		Diameter of testing pins - 20 mm - 10 mm - 6 mm - 3 mm
<b>USB</b>  	IF2004/USB 2213024 4-port RS422    IC2001 / USB 2213041    IF2001/USB converters 2213025  	<b>Signal output cable</b> SCD2500-3/10/RS422 (3 m) 2901122 (analog + signals / 10 m RS422) IF2008-Y-adaptor cable (0.1 m) 2901528 For the connection of a 3rc    <b>Signal output cables</b> SCD2500-3/RS422 (3 m) 2901111 (only RS422 open ends)	  <b>Extension cable</b>  <u>For controller receiver units:</u> CE1800-3 (3 m) 2901057  CE1800-8 (8 m) 2901058  <u>For controller light sources:</u> CE2500-3 (3 m) 2901118  CE2500-8 (8 m) 2901119	
<b>Digital output PCIE Card installation</b>  	IF2008PCIE 2213032    IF2008E 2213032  	<b>Interface cables for IF2008</b> SCD2500-3/IF2008 (3 m) 2901561 SCD2500-8/IF2008 (8 m) 2901563  IF2008-Y-adaptor cable (0.1 m) 2901528 For the connection of a 3rd or 4th sensor  		

# Interface module and accessories

## optoCONTROL

### optoCONTROL 2520

Connection	Interface modules	Connection cables	Mounting	Accessories
<b>Power supply</b> 2420096 (24V; 1A) 2420062 (24 VDC/2.5 A)  <b>Power supply</b> Power supply unit PS2031 2420096 Power supply unit PS2020 2420062		<b>Supply, interface and signal cables with open ends</b> PC/SC2520-3 (3 m) 2901918 PC/SC2520-10 (10 m) 29011037 PC/SC2520-20 (20 m) 29011038 PC/SC2520-30 (30 m) 29011039 PC/SC2520/90-5 (5 m) (90°) 29011003		<b>Demo prism</b> incl. testing pins 9335426    Diameter of testing pins - 20 mm - 10 mm - 6 mm - 3 mm
<b>PLC ProfiNET / EthernetIP</b>  	IF2035-EtherCAT 2211036 IF2035-PROFINET 2211039 IF2035-EtherNetIP 2211038  			
Serial RS422	Direct RS422 OE to PC			
Analog 0 ... 10 V	Direct 0-10 VDC			
<b>Digital output / USB / Ethernet</b>  	IC2001/USB 2213041 Converter cable  			<b>Mounting rail</b> (0.7 m) 2966033 (1.0 m) 2966034 (1.5 m) 2966035  
	IF2001/USB 2213025 Converter  			
Serial RS422	Direct RS422 to PC			
Analog 0-10 VDC	Direct 0-10 VDC			
	IF2004/USB 2213024  	<b>Interface and supply cables</b> for IF2008; PC/SC2520-3/IF2008 (3 m)  		
	IF2008PCIE 2213032  	IF2008-Y adapter cable for connection of a 3rd or 4th sensor (0.1 m)  		
	IF2008E 2213018  			
Ethernet	Directly via Ethernet to PC via RJ45	<b>Digital output cables</b> SCD2520-3 (3 m) 2901925		
<b>EtherCAT</b>  	Directly via RJ45	SCD2520-5 (5 m) (90°) 29011002 SCD2520-8 (8 m) (90°) 29011042  		
	Optional for connecting multiple 2520 sensors EK1122 2-port junction EK1100 Bus coupler			
	via EtherCAT Switch M12	SCD2520-5 M12 (5 m) 29011040		
<b>Digital output Ethernet</b>  	IF2008ETH 2213018  	<b>Supply and output cable,</b> PCE2520-3/M12 (3m) 29011343  	Connection Transmitter / Receiver CE2520-1 (1 m) 2901919 CE2520-2 (2 m) 2901920 CE2520-5 (5 m) 2901921    CE2520/90-1 (1 m) 90° 2901922 CE2520/90-2 (2 m) 90° 2901923 CE2520/90-5 (5 m) 90° 2901924	

PS2020 Power supply unit  
PS2031 Power supply unit

24 VDC / 2.5 A for mounting on DIN rail  
Universal power supply unit 100-240V/24V/ 1A

2420062  
2420096



# Basics & selection criteria

## optoCONTROL

All sensors of the optoCONTROL series operate according to the shadow casting / ThruBeam principle. A cross section of the contour of a target is measured with high accuracy. Three types of ThruBeam technologies are used in the different optoCONTROL series to cover a wide range of applications.

### Light quantity measurement (ODC1200/1201)

In light quantity measurement, an optical system fans the light from a red laser diode to create a parallel light curtain. The light curtain is aligned with the receiver unit. In the receiver unit, a precision aperture guides the light through various filters and optical components onto a light-sensitive detector. An analog electronic system processes the amount of incident light and outputs this data as an analog signal.

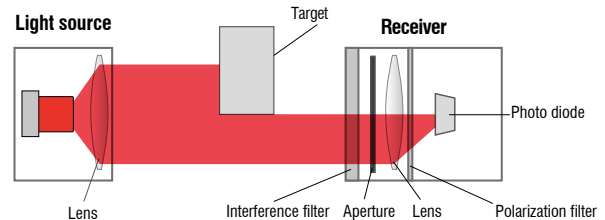

### Colometry ODC25xx

Colometry is a laser-based measuring system with an integrated high-resolution line scan camera for measuring geometric quantities. It measures the dimension of a target or the position of an edge on a body using the shadowing principle. A parallel light curtain is generated with a laser light source. The camera in the receiver unit measures the contour of the target using the shadow generated on the pixel-based array.



### Telecentric method ODC2600

The telecentric method is a measuring system with an integrated high-resolution line scan camera. The light source illuminates the target from behind. There is a telecentric objective lens in the receiver. It provides an image of the same size in the so-called telecentric range and produces a constant accuracy. The advantages of the telecentric lens are the free positioning of the target within the telecentric range ( $\pm 5$  mm) and the relatively high tolerance to contamination and ambient light. The line scan camera in the receiver also measures the projected outer contour of the target.

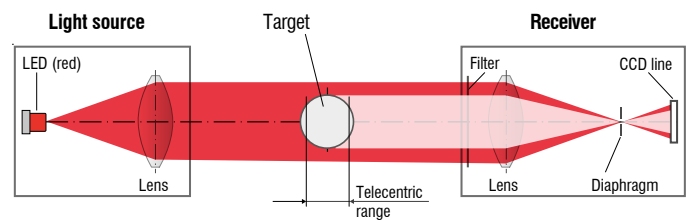

LASER RADIATION  
DO NOT VIEW DIRECTLY  
WITH TELESCOPE OPTICS  
CLASS 1M LASER PRODUCT  
IEC 60825-1: 2014  
P<2mW, Es<0.2mW/cm², λ=670nm

optoCONTROL 2520 uses a semiconductor laser, 670nm  $\leq$  2mW max. optical power, laser class 1M. No additional protective measures are required for the use of these devices. Be careful with the dazzling effect related to optical instruments.



Class 1 Laser Product  
IEC 60825-1: 2014  
P<0.39 mW; λ=670 nm  
COMPLIES WITH 21 CFR 1040.10 AND 1040.11  
EXCEPT FOR CONFORMANCE WITH IEC 60825-1  
ED. 3 AS DESCRIBED IN  
LASER NOTICE NO. 56, DATED MAY 8, 2019.

optoCONTROL 12xx uses a semiconductor laser, 670 nm,  $\leq$  0.39 mW max. optical power, laser class 1. No additional protective measures are required for the use of these devices.



Sensors and systems for displacement, distance and position



Sensors and measurement devices for non-contact temperature measurement



Measuring and inspection systems for metal strips, plastics and rubber



Optical micrometers and fiber optics, measuring and test amplifiers



Color recognition sensors, LED analyzers and inline color spectrometers



3D measurement technology for dimensional testing and surface inspection