



## Operating Instructions capa**NCDT** 6228 / 6238



CSE-1/HT/CA-1,0  
CSE-2/HT/CA-1,0  
CSE-5/HT/CA-1,0  
CSE-10/HT/CA-1,0

Non-contact Capacitive Displacement Measuring

MICRO-EPSILON  
MESSTECHNIK  
GmbH & Co. KG  
Koenigbacher Str. 15

94496 Ortenburg / Germany

Tel. +49 (0) 8542 / 168-0  
Fax +49 (0) 8542 / 168-90  
e-mail [info@micro-epsilon.com](mailto:info@micro-epsilon.com)  
[www.micro-epsilon.com](http://www.micro-epsilon.com)

# Contents

<b>1.</b>	<b>Safety .....</b>	<b>7</b>
1.1	Symbols Used .....	7
1.2	Warnings .....	7
1.3	Notes on Product Marking .....	8
	1.3.1 CE Marking .....	8
	1.3.2 UKCA Marking .....	8
1.4	Intended Use .....	9
1.5	Proper Environment .....	9
<b>2.</b>	<b>Functional Principle, Technical Data .....</b>	<b>10</b>
2.1	Measuring Principle .....	10
2.2	Structure .....	11
	2.2.1 Sensors .....	12
	2.2.2 Sensor Cable .....	14
	2.2.3 Controller .....	15
2.3	Technical Data .....	17
2.4	Options .....	19
<b>3.</b>	<b>Delivery .....</b>	<b>20</b>
3.1	Unpacking, Included in Delivery .....	20
3.2	Storage .....	20
<b>4.</b>	<b>Installation and Assembly .....</b>	<b>21</b>
4.1	Precautionary Measures .....	21
4.2	Sensor .....	21
	4.2.1 Radial Point Clamping with Grub Screw, Cylindric Sensors .....	21
	4.2.2 Circumferential Clamping, Cylindric Sensors .....	22
	4.2.3 Flat Sensors .....	22
	4.2.4 Dimensional Drawings Sensors .....	23
4.3	Sensor Cable .....	25
4.4	Controller .....	27
	4.4.1 Basic Unit, Demodulator Module .....	27
	4.4.2 Housing Cover .....	28
4.5	Insert Demodulator Module .....	29
4.6	Ground Connection, Earthing .....	32
4.7	Electrical Connections .....	33

4.7.1	Connectivity Options .....	33
4.7.2	Pin Assignment Supply, Trigger .....	34
4.7.3	Pin Assignment Analog Output .....	34
4.7.4	Pin Assignment Synchronization .....	35
<b>5.</b>	<b>Operation .....</b>	<b>37</b>
5.1	Starting Up .....	37
5.2	Operating or Display Elements .....	37
5.2.1	LED's .....	37
5.2.2	Poti .....	38
5.2.3	Change Ethernet / EtherCAT .....	39
5.3	Changing Limit Frequency .....	39
5.4	Triggering .....	40
5.5	Measurement Averaging .....	42
5.5.1	Introduction .....	42
5.5.2	Moving Average .....	42
5.5.3	Arithmetic Average Value .....	43
5.5.4	Median .....	43
5.5.5	Dynamic Noise Rejection .....	43
<b>6.</b>	<b>Ethernet Interface .....</b>	<b>44</b>
6.1	Hardware, Interface .....	44
6.2	Data Format of Measuring Values .....	48
6.3	Settings .....	49
6.4	Commands .....	52
6.4.1	Data Rate (STI) .....	52
6.4.2	Trigger Mode (TRG) .....	54
6.4.3	Get Measured Data (GMD) .....	54
6.4.4	Filter, Averaging Type (AVT) .....	55
6.4.5	Filter, Averaging Number (AVN) .....	55
6.4.6	Channel Status (CHS) .....	56
6.4.7	Mode of Linearization (LIN) .....	56
6.4.8	Set Linearization Point (SLP) .....	57
6.4.9	Get Linearization Point (GLP) .....	58
6.4.10	Status (STS) .....	58
6.4.11	Version (VER) .....	59
6.4.12	Set Mathematic Function (SMF) .....	59
6.4.13	Get Mathematic Function (GMF) .....	61
6.4.14	Clear Mathematic Function (CMF) .....	61



6.4.15	Ethernet Settings (IPS).....	62
6.4.16	Change between Ethernet and EtherCAT (IFC = Interface) .....	62
6.4.17	Query Data Port (GDP).....	63
6.4.18	Set Data Port (SDP).....	63
6.4.19	Access Channel Information (CHI).....	63
6.4.20	Access Controller Information (COI).....	64
6.4.21	Login for Web Interface (LGI).....	64
6.4.22	Logout for Web Interface (LGO).....	64
6.4.23	Change Password (PWD).....	65
6.4.24	Change Language for the Web Interface (LNG) .....	65
6.4.25	Write Measuring Range Information in Channel (MRA).....	65
6.4.26	Set Analog Filter (ALP) .....	66
6.4.27	Default Messages .....	66
6.5	Operation Using Ethernet.....	67
6.5.1	Requirements .....	67
6.5.2	Access via Web Interface .....	69
6.5.3	Operating Menu, Set Controller Parameter .....	69
6.6	Channel n.....	70
6.6.1	Channel Information, Measuring Range .....	70
6.6.2	Linearization .....	70
6.6.3	Math Function.....	72
6.7	Measurement Settings.....	73
6.7.1	Measurement Mode .....	73
6.7.1.1	Data Rate.....	73
6.7.1.2	Filter type / Averaging .....	74
6.7.1.3	Analog Low Pass Filter.....	74
6.7.2	Trigger Mode .....	74
6.8	System Settings.....	75
6.8.1	Language Selection.....	75
6.8.2	Login, Changing User Level.....	75
6.8.3	Password .....	76
6.8.4	Ethernet Settings .....	76
6.8.5	Import, Export.....	77
6.9	Firmware Update .....	77
<b>7.</b>	<b>EtherCAT Interface.....</b>	<b>78</b>
7.1	Introduction.....	78
7.2	Change Interface .....	78

<b>8.</b>	<b>Measurement</b> .....	<b>79</b>
<b>9.</b>	<b>Operation and Maintenance</b> .....	<b>80</b>
<b>10.</b>	<b>Disclaimer</b> .....	<b>81</b>
<b>11.</b>	<b>Decommissioning, Disposal</b> .....	<b>82</b>
	<b>Appendix</b> .....	<b>83</b>
<b>A 1</b>	<b>Accessories, Service</b> .....	<b>83</b>
A 1.1	Conversion Kit.....	83
A 1.2	PC6200-3/4 .....	85
A 1.3	Optional Accessories.....	85
A 1.4	Service .....	88
<b>A 2</b>	<b>Factory Setting</b> .....	<b>89</b>
<b>A 3</b>	<b>Tilt Angle Influence on the Capacitive Sensor</b> .....	<b>90</b>
<b>A 4</b>	<b>Measurement on Narrow Targets</b> .....	<b>91</b>
<b>A 5</b>	<b>Measurements on Balls and Shafts</b> .....	<b>92</b>
<b>A 6</b>	<b>EtherCAT Documentation</b> .....	<b>93</b>
A 6.1	Preamble.....	93
A 6.1.1	Structure of EtherCAT®-Frames .....	93
A 6.1.2	EtherCAT® Services.....	94
A 6.1.3	Addressing and FMMUs.....	95
A 6.1.4	Sync Manager .....	95
A 6.1.5	EtherCAT State Machine .....	96
A 6.1.6	CANopen over EtherCAT.....	97
A 6.1.7	Process Data PDO Mapping .....	97
A 6.1.8	Service Data SDO Service.....	98
A 6.2	CoE – Object Directory.....	98
A 6.2.1	Communication Specific Standard Objects (CiA DS-301) .....	98
A 6.2.2	Manufacturer Specific Objects.....	101
A 6.3	Measurement Data Format.....	104
A 6.4	EtherCAT Configuration with the Beckhoff TwinCAT®-Manager.....	105

## 1. Safety

System operation assumes knowledge of the operating instructions.

### 1.1 Symbols Used

The following symbols are used in these operating instructions:



Indicates a hazardous situation which, if not avoided, may result in minor or moderate injury.



Indicates a situation that may result in property damage if not avoided.



Indicates a user action.



Indicates a tip for users.

Measure

Indicates hardware or a software button/menu.

### 1.2 Warnings



Disconnect the power supply before touching the sensor surface.

- > Risk of injury
- > Static discharge

Connect the power supply and the display/output device according to the safety regulations for electrical equipment.

- > Risk of injury
- > Damage to or destruction of the sensor and/or controller

**NOTICE**

Avoid shocks and impacts to the sensor and controller.

- > Damage to or destruction of the sensor and/or controller

The supply voltage must not exceed the specified limits.

- > Damage to or destruction of the sensor and/or controller

Protect the sensor cable against damage

> Destruction of the sensor

> Failure of the measuring device

### **1.3 Notes on Product Marking**

#### **1.3.1 CE Marking**

The following applies to the product:

- Directive 2014/30/EU (“EMC“)
- Directive 2011/65/EU (“RoHS“)

Products which carry the CE marking satisfy the requirements of the EU Directives cited and the relevant applicable harmonized European standards (EN). The product is designed for use in industrial and laboratory environments.

The EU Declaration of Conformity and the technical documentation are available to the responsible authorities according to the EU Directives.

#### **1.3.2 UKCA Marking**

The following applies to the product:

- SI 2016 No. 1091 (“EMC“)
- SI 2012 No. 3032 (“RoHS“)

Products which carry the UKCA marking satisfy the requirements of the directives cited and the relevant applicable harmonized standards. The product is designed or use in industrial and laboratory environments.

The UKCA Declaration of Conformity and the technical documentation are available to the responsible authorities according to the UKCA Directives.

## 1.4 Intended Use

- The capaNCDT 62x8 measuring system is designed for use in industrial areas. It is used for
  - displacement, distance, thickness and movement measurement
  - position measuring of parts or machine components
- The system must only be operated within the limits specified in the technical data, [see 2.3](#).

➡ The system must be used in such a way that no persons are endangered or machines and other material goods are damaged in the event of malfunction or total failure of the system.

➡ Take additional precautions for safety and damage prevention in case of safety-related applications.

## 1.5 Proper Environment

- Protection class: IP40
- Temperature range
  - Operation:
    - Sensor (CSE-x/HT/CA-1,0) with cable: -50 ... +800 °C (-58 to +1472 °F)
    - Connector (CSE-x/HT/CA-1,0): -50 ... +200 °C (-58 to +392 °F)
    - Sensor: -50 ... +200 °C (-58 to +392 °F)
    - Sensor cable:
      - 50... +200 C (-58 to +392 °F) (CCmx and CCmx/90)
      - 20 ... +80 °C (-58 to +392 °F) (CCgx and CCgx/90 - permanently)
      - 20 ... +100 °C (-58 to +392 °F) (CCgx and CCgx/90 - 10,000 h)
      - +10 ... +60 °C (+50 to +140 °F)
  - Controller:
    - Sensor: -50 ... +200 °C (-58 to +392 °F) <sup>1</sup>
    - Sensor cable:
      - 50 ... +200 °C (-58 to +392 °F) (CCmx and CCmx/90)
      - 50 ... +80 °C (-58 to +176 °F) (CCgx and CCgx/90)
  - Controller:
    - -10 ... +75 °C (+14 to +167 °F)
- Humidity: 5 - 95 % (non-condensing)
- Ambient pressure: Atmospheric pressure
- The space between the sensor surface and the target must have an unvarying dielectric constant.
- The space between the sensor surface and the target may not be contaminated (for example water, rubbed-off parts, dust, etc.)

## 2. Functional Principle, Technical Data

### 2.1 Measuring Principle

The principle of capacitive distance measurement with the capaNCDT system is based on the principle of the parallel plate capacitor. For conductive targets, the sensor and the target opposite form the two plate electrodes.

If a constant AC current flows through the sensor capacitor, the amplitude of the AC voltage at the sensor is proportional to the distance between the capacitor electrodes. The AC voltage is demodulated, amplified and output as an analog signal.

The capaNCDT system evaluates the reactance  $X_C$  of the plate capacitor which changes strictly in proportion to the distance.

$$X_C = \frac{1}{j\omega C}; \quad \text{capacitance } C = \epsilon_r \epsilon_o \frac{\text{area}}{\text{distance}}$$

**i** A small target and bent (uneven) surfaces cause a non-linear characteristic.

This theoretical relationship is realized almost ideally in practice by designing the sensors as guard ring capacitors.

The linear characteristic of the measuring signal is achieved for electrically conductive target materials (metals) without any additional electronic linearization. Slight changes in the conductivity or magnetic properties do not affect the sensitivity or linearity.

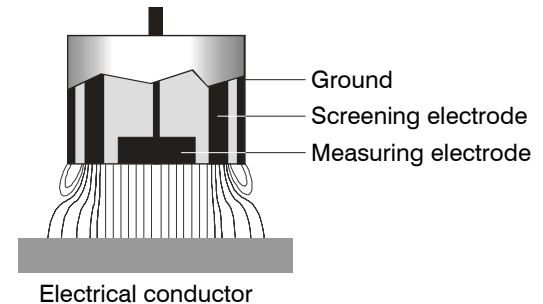

Fig. 1 Functional principle of the guard ring capacitor

## 2.2 Structure

The non-contact, multi-channel measuring system, installed in an aluminum housing, consists of:

- A basic module DT6228 or DT6238
- A demodulator module DL6228, each with integrated preamplifier per sensor
- Sensor
- Sensor cable
- Power supply cable
- Ethernet cable
- Signal output cable

The modular assembly allows to join up to 4 channels (module system).

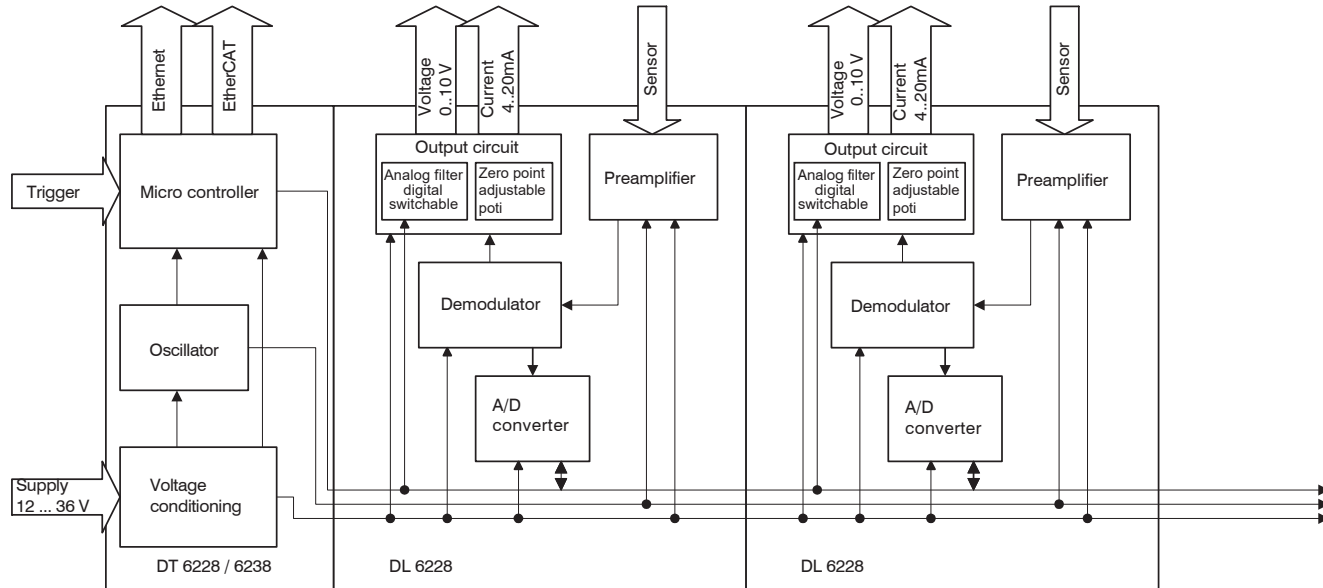

Fig. 2 Block diagram capaNCDT 62x8

capaNCDT 6228 / 6238

### 2.2.1 Sensors

For this measurement system, several sensors can be used.

➡ In order to obtain accurate measuring results, keep the surface of the sensor clean and free from damage.

The capacitive measuring process is area-related. A minimum area (see table) is required depending on the sensor model and measuring range. In the case of insulators the dielectric constant and the target thickness also play an important role.

#### Sensors for electrical conducting targets (metals)

Sensor model	Measuring range	Min. target diameter
CS005	0.05 mm	3 mm
CS02	0.2 mm	5 mm
CSH02	0.2 mm	7 mm
CSH02FL	0.2 mm	7 mm
CS05	0.5 mm	7 mm
CSE05	0.5 mm	6 mm
CSE05/M6	0.5 mm	6 mm
CSH05	0.5 mm	7 mm
CSH05FL	0.5 mm	7 mm
CS08	0.8 mm	9 mm
CS1	1 mm	9 mm
CSE1	1 mm	8 mm
CSE1,25/M12	1.25 mm	10 mm
CSH1	1 mm	11 mm
CSH1FL	1 mm	11 mm
CS1HP	1 mm	9 mm



<b>Sensor model</b>	<b>Measuring range</b>	<b>Min. target diameter</b>
CSH1,2	1.2 mm	11 mm
CSH1.FL	1.2 mm	11 mm
CSH2FL	2 mm	17 mm
CS2	2 mm	17 mm
CSH2	2 mm	17 mm
CSE2	2 mm	14 mm
CSE2/M16	2 mm	14 mm
CS3	3 mm	27 mm
CSE3/M24	3 mm	20 mm
CSH3FL	3 mm	24 mm
CS5	5 mm	37 mm
CS10	10 mm	57 mm
CSG0.50	0.5 mm	approx. 7 x 8 mm
CSG1.00	1.00 mm	approx. 8 x 9 mm
CSE-1/HT/CA-1,0	1 mm	8 mm
CSE-2/HT/CA-1,0	2 mm	14 mm
CSE-5/HT/CA-1,0	5 mm	30 mm
CSE-10/HT/CA-1,0	10 mm	50 mm

### 2.2.2 Sensor Cable

Sensor and controller are connected by a special, double screened sensor cable.

Do not shorten or lengthen these special cables.

Usually, a damaged cable can not be repaired.

#### NOTICE

Switch off the device when plugging and removing connectors.

Do not crush the sensor cable.

Do not modify to the sensor cable.

> Lost of functionality

Model	Cable length	Cable ø	2 axial connector	1x axial + 1x 90°	For sensors	Min. bending radius	
						once	permanently
CCgxC	2/4 or 6 m	3.1 mm	•		0.05 - 0.8 mm	10 mm	22 mm
CCgxC/90	2/4 or 6 m	3.1 mm		•	0.05 - 0.8 mm		
CCgxB	2/4 or 6 m	3.1 mm	•		1 ... 10 mm		
CCgxB/90	2/4 or 6 m	3.1 mm		•	1 ... 10 mm		
CCmxC	1.4/2.8 or 4.2 m	2.1 mm	•		0.05 - 0.8 mm	7 mm	15 mm
CCmxC/90	1.4/2.8 or 4.2 m	2.1 mm		•	0.05 - 0.8 mm		
CCmxB	1.4/2.8 or 4.2 m	2.1 mm	•		1 ... 10 mm		
CCmxB/90	1.4/2.8 or 4.2 m	2.1 mm		•	1 ... 10 mm		

The sensors of type CSH have integrated a 1.4 long sensor cable. Cable lengths of 2.8 m are available too if required.

Other cable lengths are also available on request.

The sensor model CSE1 (measuring range 1 mm) has the connector type C.

### 2.2.3 Controller

The capaNCDT 62x8 Multi-channel measuring system consists of a basic module DT62x8 and one up to four demodulator modules DL6228, according to requirements. The components are stored in aluminum housings.



Fig. 3 Front view basic module DT6238 with 2 demodulator modules DL6228



Fig. 4 Front view basic module DT6228 with 2 demodulator modules DL6228

#### Basic module DT62x8

The basic module consists of the units voltage conditioning, oscillator and digital unit.

The voltage conditioning generates all required internal voltages from the supply voltage, both for the basic module as well as the connected demodulator modules. The oscillator supplies the demodulator modules with constant frequency and amplitude-stable alternating current. The digital unit controls the A/D converter of the demodulator modules and measures the actual measuring values. The measuring values can be read out via the Ethernet interface in digital form, [see 6](#).

### **Demodulator module DL6228**

The demodulator module DL6228 consists of an internal preamplifier, demodulator, output stage and A/D converter. The internal preamplifier generates the distance dependent measuring signal and amplifies it. Demodulator and output stage convert the measuring signal in a standardized voltage and current signal. The measuring values can be processed digitally with the help of the A/D converter.

The trim potentiometer zero allows a special zero adjustment of the analog output signals, [see Fig. 3](#).

**i** Output voltage can achieve up to 15 VDC, if the sensor is disconnected respectively exceedance of measuring range.

## 2.3 Technical Data

Controller type	DT6228	DT6238
<b>with demodulator</b>	<b>DL6228</b>	
Resolution <sup>1</sup>	Static (20 Hz)	0.004% FSO
	Dynamic (1 kHz)	0.01% FSO
Frequency response (-3dB)	1 kHz, switchable to 20 Hz	
Measuring rate	max. 3.906 kSa/s	
Linearity <sup>2</sup>	± 0.05 % FSO	
Temperature stability	< 200 ppm FSO/K	
Sensitivity	< ±0.1 % FSO	
Long-term stability	≤ 0.02% FSO/month	
Synchronization	yes (only internal)	yes
Supply voltage	12 ... 36 VDC	15 ... 36 VDC
Power consumption	3.1 W (24 VDC) + 1.8 / demodulator	3.8 W (24 VDC) + 1.8 / demodulator
Signal input	TTL (5V)	
Digital interface	Ethernet	Ethernet/EtherCAT
Analog output	0 ... 10 V / 4 ... 20 mA	
Connector	Sensor: pluggable cable via triaxial socket; Supply/trigger: 4-pin connector; Sync: 5-pin connector; Signal: analog via 4-pin connector, digital via RJ45 connector (see accessories for suitable connection cables)	
Mounting	Table-top device or DIN rail	
Temperature range	Storage	-10 ... +75 °C
	Operation	+10 ... +60 °C
Shock (DIN EN 60068-2-27)	15 g / 6 ms in 3 axes, two directions each, 1000 shocks each	

<b>Controller type</b>	<b>DT6228</b>	<b>DT6238</b>
Vibration (DIN EN 60068-2-6)	0.75 mm / 10 ... 500 Hz in 3 axes, 2 directions each and 10 cycles each 2 g / 10 ... 500 Hz in 3 axes, 2 directions and 10 cycles each	
Protection class (DIN EN 60529)	IP40	
Weight	approx. 720 g + 185 g / demodulator	approx. 720 g + 210 g / demodulator
Compatibility	compatible with all capaNCDT sensors	
No. of measurement channels	max. 4	

1) RMS noise relates to mid of measuring range

2) Applies only to controller. The overall linearity of the measuring channel is given by adding up the values for the controller and the sensor.

<b>Controller type</b>	<b>DT62x8 with DL6228</b>
Sensors	all sensors suitable
Sensor cable standard	CCm1.4x; CCg2.0x
Sensor cable (matched)	≤ 8 m (with CCgxx) ≤ 5.6 m (with CCmxx)
Trigger	TTL, 5 V

FSO = Full Scale Output

## 2.4 Options

The following options are available for article DL6228:

<b>Designation</b>	<b>Description</b>
LC DL62x0 digital	Special calibration of linearity on digital output
LC DL62x0 analog	Special calibration on linearity on analog output
ECL2 DL6220	Special tuning for 2 times sensor cable length
ECL3 DL6220	Special tuning for 3 times sensor cable length
EMR2 DL6220	Extended measuring range (factor: 2)
RMR1/2 DL6220	Shortened measuring range (factor: 1/2)

### 3. Delivery

#### 3.1 Unpacking, Included in Delivery

1 Basic module DT62x8 with 1 - 4 demodulator modules DL6228

1 Power supply and trigger cable PC6200-3/4, 3 m long, [see A 1.3](#)

1 Ethernet cable, 3 m long

1 Conversion kit (Springs for mounting on DIN-rail, mounting plates for wall fastening, threaded rods in different lengths), [see A 1.1](#).

Optional accessories:

1 Sensor

1 Sensor cable with connector

Signal output cable, synchronization cable, [see A 1.3](#).

- Carefully remove the components of the measuring system from the packaging and ensure that the goods are forwarded in such a way that no damage can occur.
- Check for completeness and shipping damages immediately after unpacking.
- If there is damage or parts are missing, immediately contact the manufacturer or supplier.

#### 3.2 Storage

- Temperature range storage:

- Sensor: -50 ... +200 °C (-58 to +392 °F) <sup>1</sup>
  - Sensor cable: -50 ... +200 °C (-58 to +392 °F) (CCmx and CCmx/90)  
-50 ... +80 °C (-57 to +176 °F) (CCgx and CCgx/90)
  - Controller: -10 ... +75 °C (+14 to +167 °F)
- Humidity: 5 - 95 % RH (non-condensing)

1) A storage temperature of -50 ... +100 °C (-58 to +212 °F) applies for the sensors CSG0.50-CA and CSG1.00-CA -50



## 4. Installation and Assembly

### 4.1 Precautionary Measures

No sharp-edged or heavy objects may get into contact with the sensor cable sheath.

- Protect the cable against pressure loads in pressurised rooms.
- Avoid kinks in any case.
- Check the connections for tight fit.

**i** A damaged cable cannot be repaired.

### 4.2 Sensor

The sensors may be mounted free-standing or flush.

When assembling, make sure that the polished sensor surface is not scratched.

#### 4.2.1 Radial Point Clamping with Grub Screw, Cylindric Sensors

This simple type of fixture is only recommended for a force and vibration-free installation position. The grub screw must be made of plastic so that it cannot damage or deform the sensor housing.

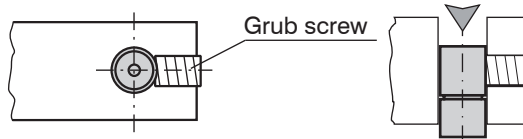

*Fig. 5 Radial point clamping with grub screw*

#### **NOTICE**

Do not use metal grub screws!

> Danger of damaging the sensor

### 4.2.2 Circumferential Clamping, Cylindric Sensors

This sensor mounting option offers maximum reliability because the sensor is clamped around its cylindrical housing. It is absolutely necessary in difficult installation environments, for example on machines, production plants et cetera.

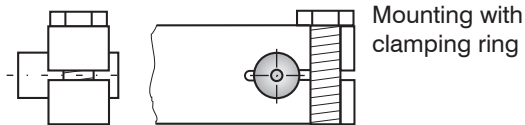

Mounting with clamping ring

Fig. 6 Circumferential clamping

**i** Tension at the cable is inadmissible!

### 4.2.3 Flat Sensors

Flat sensors are mounted by means of a tap hole for M2 (in case of sensors 0.2 and 0.5 mm) or by a through hole for M2 screws. The sensors can be bolted on top or below.

**Screwing from above**

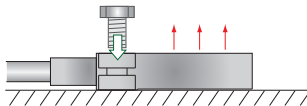

**Screwing from bottom**

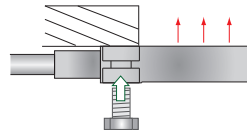

t to scale

### 4.2.4 Dimensional Drawings Sensors

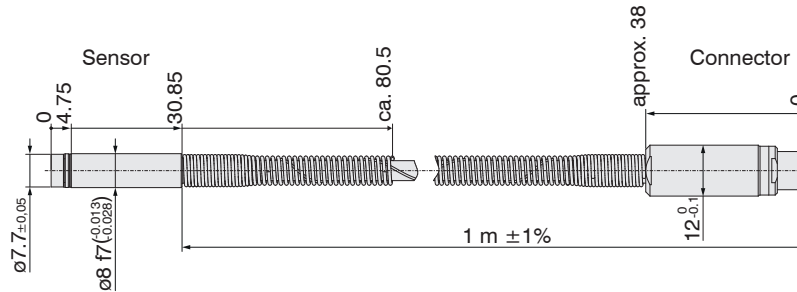

Fig. 7 CSE-1/HT/CA-1,0

Dimensions in mm  
(inches)

Circumferential clamping possible from 3 mm behind the front face.

Dimensional drawings of other sensors are available on request.

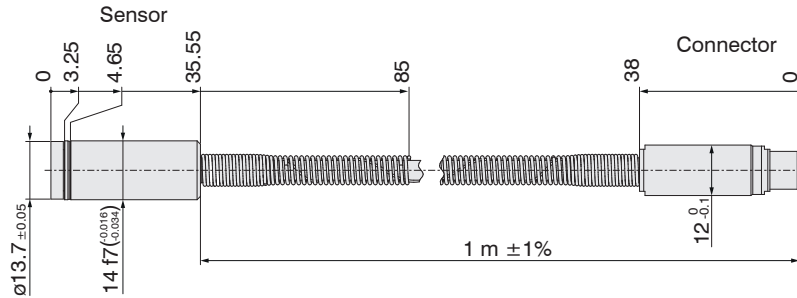

Fig. 8 CSE-2/HT/CA-1,0

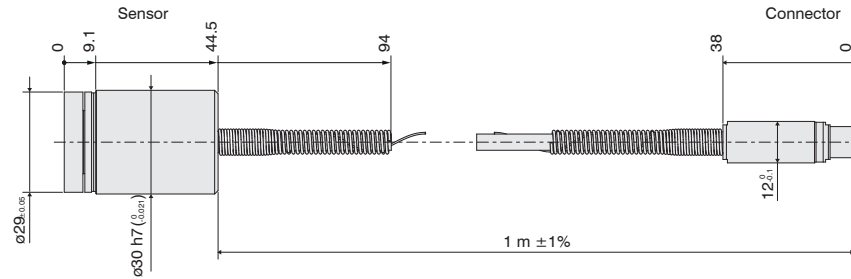

Fig. 9 CSE-5/HT/CA-1,0

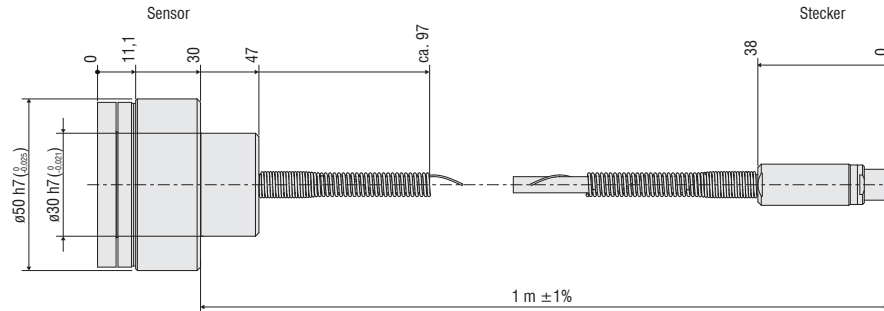
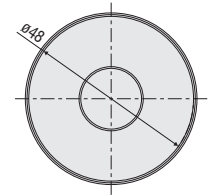

Fig. 10 CSE-10/HT/CA-1,0

Dimensions in mm  
(inches)

Circumferential clamping possible from 6 mm behind the front face.

Dimensional drawings of other sensors are available on request.



### 4.3 Sensor Cable

The sensor is connected to the controller by the sensor cable. The connection is made by simple plugging. The connector locks automatically. The tight fit can be checked by pulling the connector housing (cable bushing). The lock can be released and the connector can be opened by pulling the knurled housing sleeve of the cable bushing.

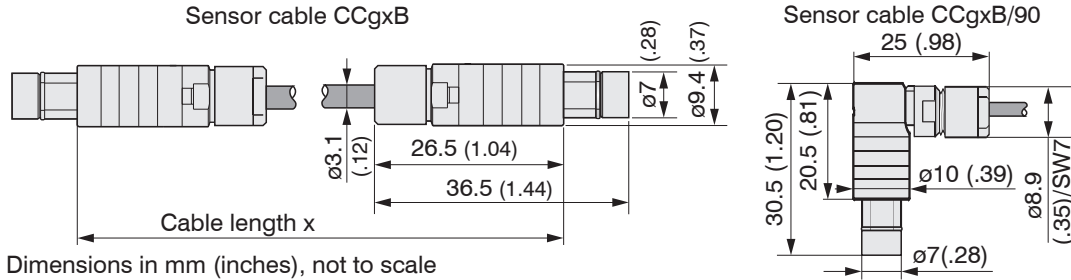

Model	Cable length	Cable $\phi$	2 axial connector	1x axial + 1x 90°	For sensors	Min. bending radius	
CCgxB	2 / 4 or 6 m	3.1 mm	•		1 ... 10 mm	10 mm (once)	22 mm (permanently)
CCgxB/90	2 / 4 or 6 m	3.1 mm		•	1 ... 10 mm		

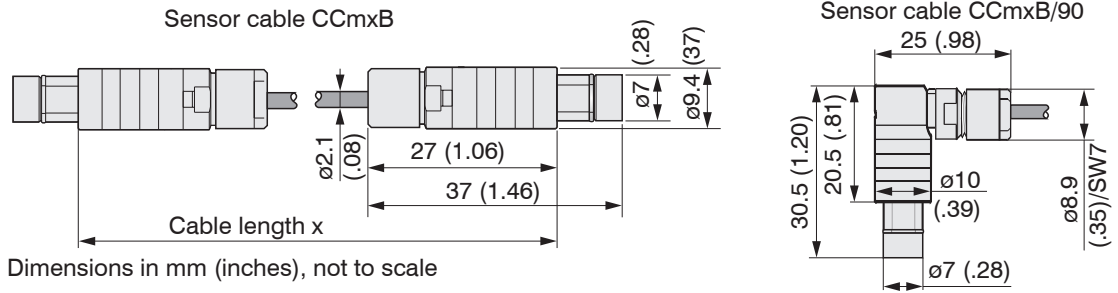

Model	Cable length	Cable $\phi$	2 axial connector	1x axial + 1x 90°	For sensors	Min. bending radius	
						7 mm (once)	15 mm (permanently)
CCmxB	1.4 / 2.8 / 4,2 m	2.1 mm	•		1 ... 10 mm	7 mm (once)	15 mm (permanently)
CCmxB/90	1.4 / 2.8 / 4.2 m	2.1 mm		•	1 ... 10 mm		

## 4.4 Controller

### 4.4.1 Basic Unit, Demodulator Module

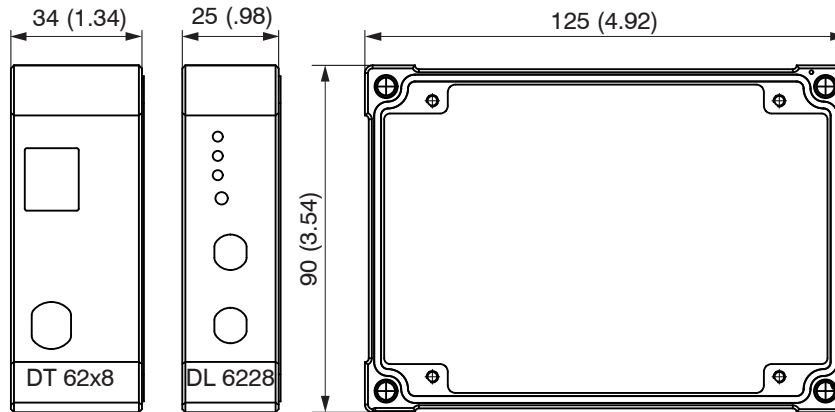

*Fig. 11 Dimensional drawing controller*

Dimensions in mm (inches), not to scale

### 4.4.2 Housing Cover

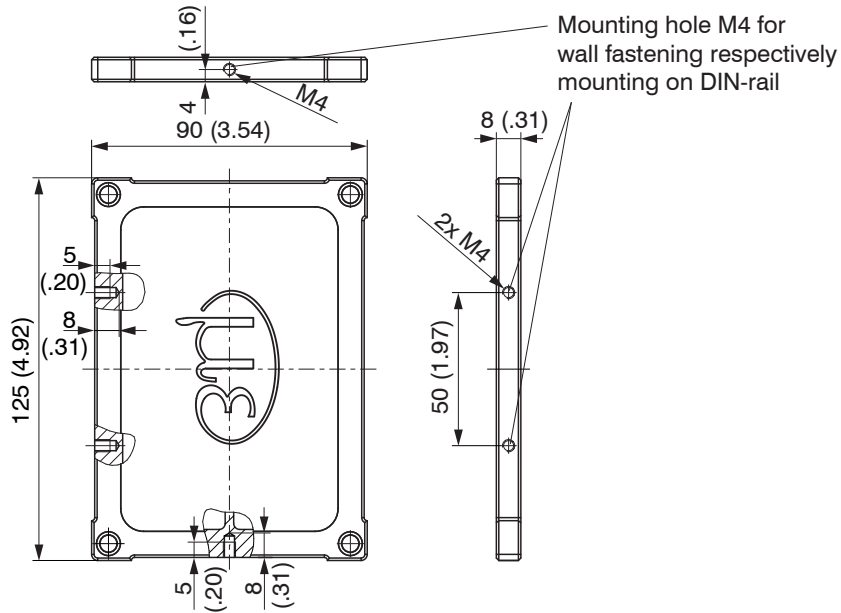

Fig. 12 Dimensional drawing housing cover

Dimensions in mm (inches), not to scale

The controller is mounted using mounting plates or holding clamps for a mounting on DIN-rail which are included with the conversion kit supplied, [see A 1.1](#).



### 4.5 Insert Demodulator Module

- ➡ Unscrew the sleeve nuts (4b) on the right side of the controller, remove the right housing cover (3).
  - ➡ Remove a sleeve nut (4a) with threaded rod (1).
  - ➡ Successively replace the threaded rod (1) by a threaded rod next longer from the supplied conversion kit. Move the new threaded rod with the sleeve nut (4a) through the modules.
  - ➡ Exchange the remaining 3 threaded rods in such a way.
- i** Touch the demodulator modules only at the housing, not at the electronics. This will prevent electrostatic discharges on the electronics.
- ➡ Attach the additional demodulator module.

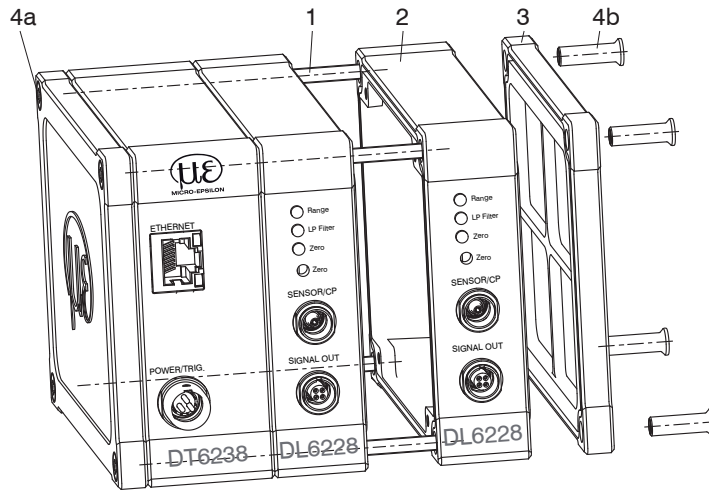

Number demodulator modules	Length threaded rod M4
1	59 mm
2	84 mm
3	109 mm
4	134 mm

Fig. 13 Mechanical components controller

- ➡ Connect both flat flexible cables (5) of the preceding demodulator module with the new demodulator module (6).

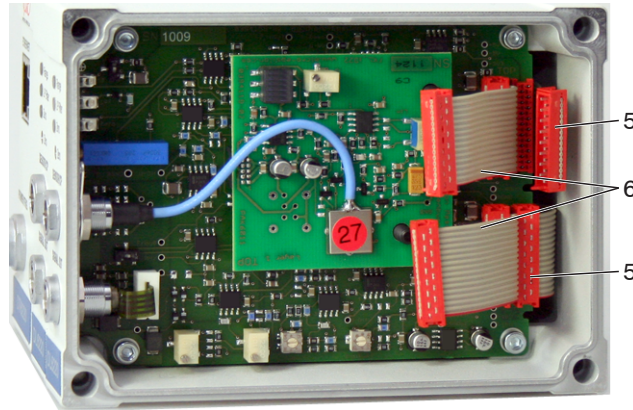

- 5 Wiring preceding demodulator module
- 6 Wiring following demodulator module

*Fig. 14 Wiring demodulator modules*

- ➡ Put on the right housing cover (3).
- ➡ Screw the sleeve nuts (4b) on the threaded rods on the right side of the controller and tighten the sleeve nuts.

The wiring to the preceding demodulator module (5) can be solved using the supplied plugging off assistance, see [A 1.1](#) as follows:

- ▶ 1. Press the plugging off assistance with the recess laterally to the connector (5).
- ▶ 2. Loosen the connector with a lever movement.
- ▶ 3. Loosen the other side of the connector in the same way.

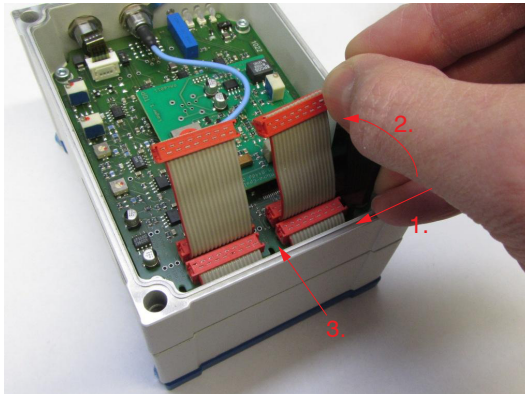

*Fig. 15 Use of the plugging off assistance for the wiring of the demodulator elements*

## 4.6 Ground Connection, Earthing

- ➡ Make sure you have a sufficient grounding of the measuring object, for example connect it with the sensor or the supply ground.

### Non-contact target earthing

In several applications, the target earthing is difficult or even impossible.

Different to other systems, with capaNCDT systems is no target earthing necessary

The drawing below shows two synchronized capaNCDT sensors, measuring against a mill, see Fig. 16. Due to the unique synchronizing technique of MICRO-EPSILON a special target earthing is not needed in most cases.

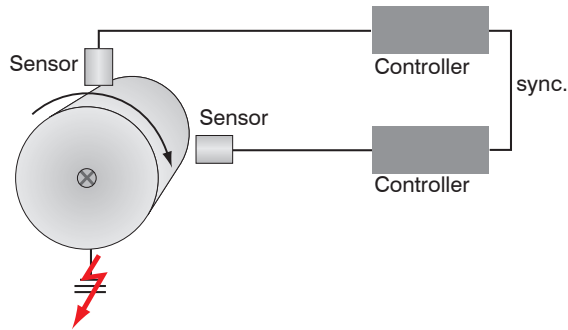

Fig. 16 Position and unbalance measuring with two measuring systems

No target grounding required with two synchronized capaNCDT sensors.

If necessary use the ground connection on the housing cover. The ground connection is included with the conversion kit supplied, see A 1.1.



Fig. 17 Ground connection on the housing cover

## 4.7 Electrical Connections

### 4.7.1 Connectivity Options

The power supply and the signal output are located at the front side of the controller.

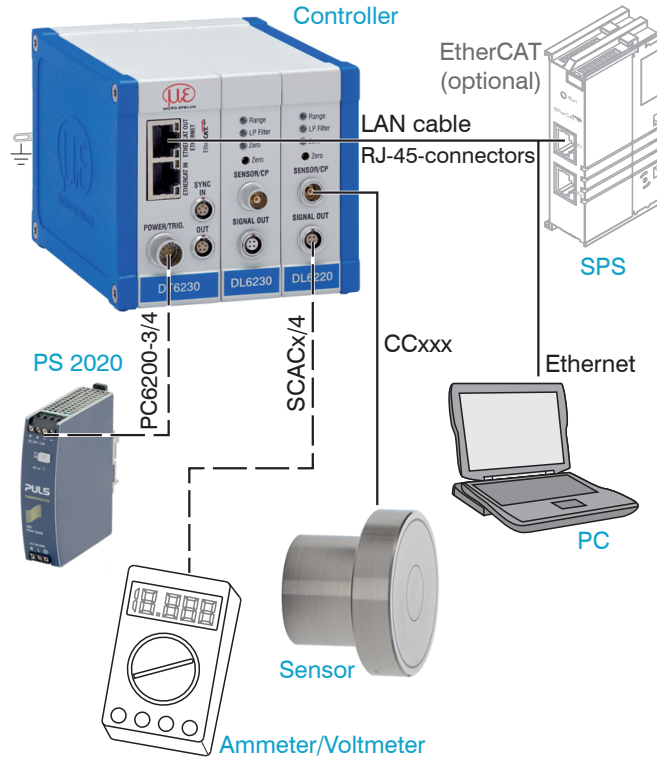
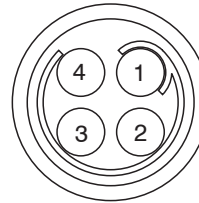

Fig. 18 Measuring system assembly

### 4.7.2 Pin Assignment Supply, Trigger

PIN	Color PC6200-3/4	Description
1	Brown	+24 VDC Supply
2	White	GND Supply
3	Yellow	Trigger IN+, TTL level
4	Green	Trigger IN-
Shield		

PC6000-3/4 is a 3 m (13.12 ft) long, pre-assembled power supply and trigger cable.



View on solder pin side, 4-pole ODU female cable connector

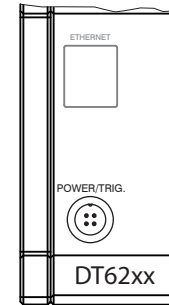

Power supply input on controller, 4-pole male cable connector

### 4.7.3 Pin Assignment Analog Output

Pin	Color SCACx/4	Description
1	Brown	$V_{OUT}^P$ (Load min. 10 kOhm)
2	Yellow	$I_{OUT}^P$ (Load max. 500 Ohm)
3	Gray	Analog ground
4	White	Analog ground
Shield		

Analog grounds are connected internally. SCACx/4 is a 3 m (13.12 ft) long, 4-wire output cable. It is supplied as an optional accessory.

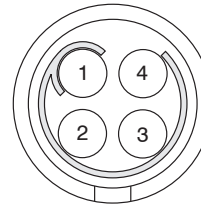

View on solder pin side, 4-pole male cable connector

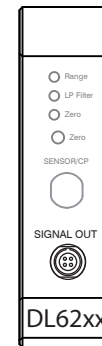

Signal output on controller, 4-pole male cable connector

#### 4.7.4 Pin Assignment Synchronization

PIN	Assignment	Insulation	Color
1	n.c	-	-
2	Twisted Pair 1	1	White 1
3	Twisted Pair 1	Blue	Blue
4	Twisted Pair 2	2	White 2
5	Twisted Pair 2	Orange	Orange

SC6000-x is a 0,3 or 1 m long, preassembled synchronization cable

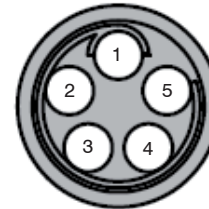

View on solder pin side, 5-pin ODU male cable connector

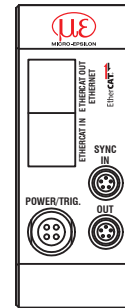

Sync IN/OUT on controller, 5-pin female cable connector

Several measuring systems series capaNCDT 6238 can simultaneously be used as multi-channel system. With the synchronization of the systems, a mutual influence of the sensors is avoided.

- ➡ Plug the synchronization cable SC6000-x, [see A 1.4](#), into the female connector SYNC OUT (Synchronization output) at the controller 1.
- ➡ Plug the connector of SC6000-x into the female connector SYNC IN (synchronization input) at controller 2.

The oscillator of controller 2 switches automatically into synchronization, this means, depending on the oscillator 1 of Controller 1.

An influence of poor earthed target is excepted.

Synchronize possibly several measuring systems with a SC6000-x.

- **i** Automatic synchronization. Every controller can be master.

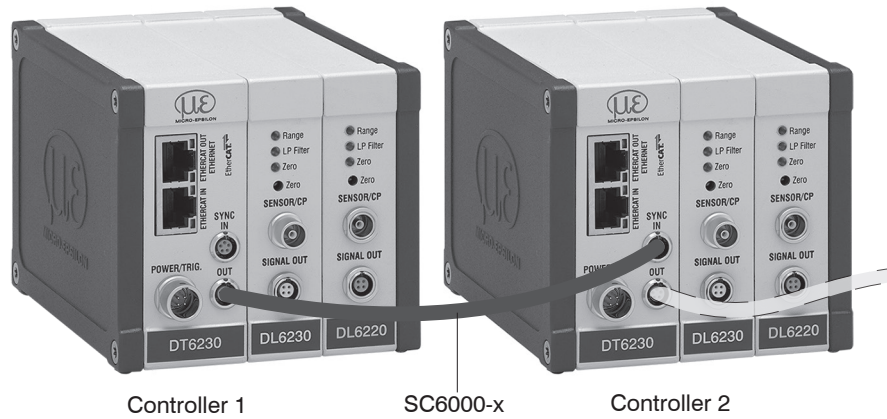

Fig. 19 Synchronization of a second controller



## 5. Operation

### 5.1 Starting Up

➡ Connect the the display/output devices through the signal output socket, [see 4.7](#), [see 4.7.2](#), [see 4.7.3](#), before connecting the device to the power supply and switching on the power supply.

**i** Allow the measuring system to warm up before the first measurement or calibration for approximately 15 min.

### 5.2 Operating or Display Elements

#### 5.2.1 LED's

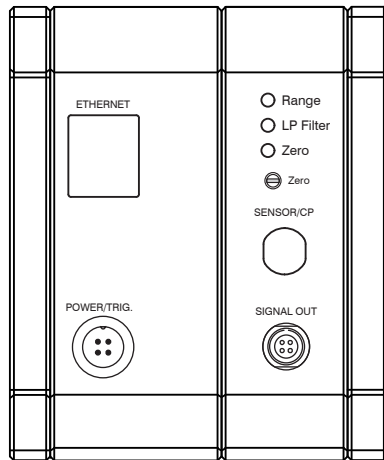

1) LP Filter only switchable via Ethernet.

LED	Color		Function
Range	☀	Green	Target in measuring range
		Red	Measuring range exceeded
LP Filter <sup>1</sup>	○	Off	Standard bandwidth active
	☀	Red	20 Hz Low-pass filter on the analog outputs enabled
Zero	○	Off	Zero poti in basic position (right stop)
	☀	Red	Zero poti adjusted

### 5.2.2 Poti

The zero-poti on the demodulator modules is used for zero adjustment of the analog outputs.

End positions on the left or right stop are marked by a slight click.

The electrical zero point can be set across the whole measuring range with the “zero” potentiometer. The start of the measuring range (= mechanical zero point) is on the front face of the sensor.

A tilted sensor or measuring object results in a reduced measuring range and zero point shifting according to the tilting.

The potentiometer is ex factory set at the right stop (maximum level).

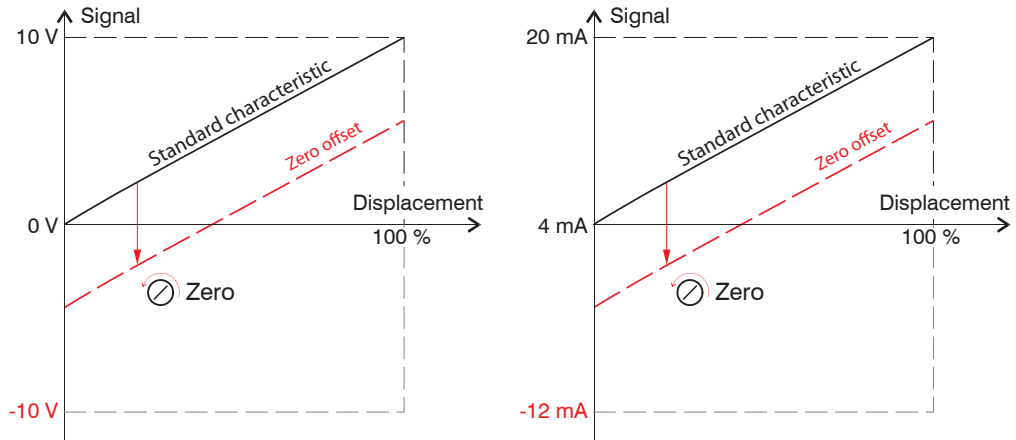

Fig. 20 Zero point shifting with zero-poti

### 5.2.3 Change Ethernet / EtherCAT

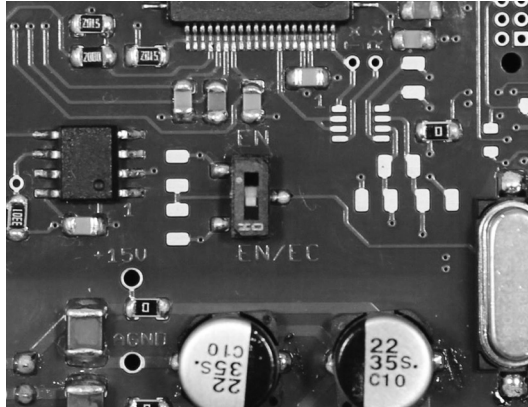

Fig. 21 Change Ethernet/EtherCAT

A switch between Ethernet and EtherCAT, is possible via a hardware switch, see Fig. 21 or via software on the basic unit DT6238, see 7.2.

If the switch is in position **EN** (Ethernet), always the Ethernet interface is active independent of the software setting. If the switch is in position **EN/EC** (Ethernet/EtherCAT), then the active interface depends on the software setting. To change the interface it is necessary to restart the controller.

### 5.3 Changing Limit Frequency

The controller operates with a limit frequency of 1 kHz (factory setting). In case that the limit frequency is reduced to 20 Hz, the output signal is filtered more efficiently and the resolution is therefore improved; at the same time the dynamic of the system is reduced. The limit frequency can only be changed via the Ethernet interface.

## 5.4 Triggering

The measuring value output on capaNCDT 62x8 is controllable by an external electrical trigger signal or command. Here, only the digital output is affected.

Triggering release by:

- Trigger input (pin 3 and pin 4 on 4-pole power supply connector, [see 4.7.2](#) or
- Software command \$GMD, [see 6.4.3](#)
- $V_{IN}$ , HIGH  $\geq 2,0$  V
- $V_{IN}$ , LOW  $\leq 0,8$  V

Fig. 22 Trigger Input

The trigger type is determined by the command \$TRGn, [see 6.4.2](#) or

- the web interface, [see 6.7.2](#)

Level triggering (high level). Continuous measurement output with adjusted data rate, as long as the selected level is active. After that the controller stops the output of the measuring values.

Fig. 23 Active high level trigger ( $V_I$ ), relevant digital signal ( $D_0$ )

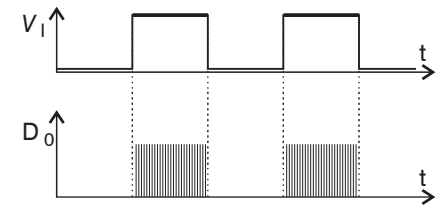
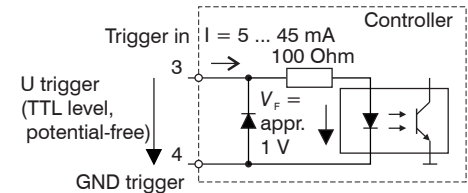

Edge triggering. Starts measuring value output, as soon as the rising edge on the trigger input is active. If trigger conditions are met, the controller outputs a measuring value. The set data rate must be greater than the maximum trigger frequency. If triggering is faster than the set data rate, individual measuring values are transmitted twice, because internally no new measuring values of the AD converter are active.

The duration of the pulse must be at least  $5 \mu\text{s}$ .

*Fig. 24 Rising edge trigger ( $V_i$ ), relevant digital signal ( $D_o$ )*

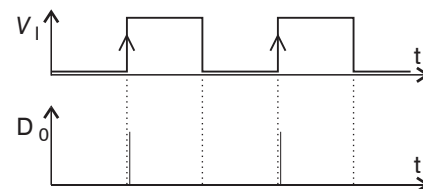

Gate rising edge. Starts measuring value output with set data rate, as soon as the rising edge on the trigger input is active. Another rising edge stops the measuring value output respectively switches it on again.

*Fig. 25 Rising edge trigger ( $V_i$ ), relevant digital signal ( $D_o$ )*

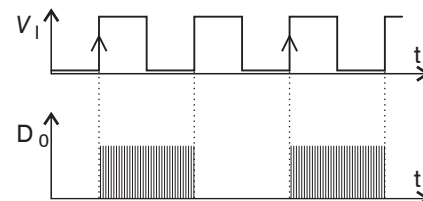

Software triggering (\$GMD). A measuring value is output per channel, as soon as a command is sent. The point of time is not defined as accurately.

No trigger is set ex factory. The controller starts the data transfer immediately after the switching on.

## 5.5 Measurement Averaging

### 5.5.1 Introduction

Measurement averaging is performed before the output of measuring values via the Ethernet interfaces. Measurement averaging improves the resolution, allows masking individual interference points or “smoothes” the reading.

**i** Linearity is not affected by averaging. Averaging has no effect on measuring frequency and output rate.

The controller is delivered ex factory without measurement averaging.

### 5.5.2 Moving Average

The definable number N for successive measurements (window width) is used to calculate the arithmetic average  $M_{mov}$  according to the following formula:

$$M_{mov} = \frac{\sum_{k=1}^N MV_k}{N}$$

$MV$  = Measuring value  
 $N$  = Number  
 $k$  = Continuous index  
 $M_{mov}$  = Average value

Fig. 26 Formula for the moving average

#### Method

Each new measured value is added, and the first (oldest) value is removed from the averaging.

Example with  $N = 7$ :

.... 0 1 2 3 4 5 6 7 8 gets to  $\frac{2+3+4+5+6+7+8}{7}$  Average value n

.... 1 2 3 4 5 6 7 8 9 gets to  $\frac{3+4+5+6+7+8+9}{7}$  Average value n + 1

### 5.5.3 Arithmetic Average Value

The arithmetic average value  $M$  is set and output over the selected number  $N$  of successive measuring values.

#### Method

Measuring values are collected and the average value is calculated consequently. This method leads to a reduction of the amount of data, because an average value is output only after every  $N$ th measuring value.

Example with  $N = 3$ :

... 0 1 2 3 4... gets to  $\frac{2+3+4}{3}$  Average value  $n$

... 3 4 5 6 7... gets to  $\frac{5+6+7}{3}$  Average value  $n + 1$

### 5.5.4 Median

A median value is formed from a preselected number of measurements. For this, the incoming values are sorted after each measurement. Then, the average value is provided as the median value.

If a even value is selected for the average number  $N$ , middle both measuring values are added and divided by two.

Example with  $N = 7$ :

... 2 4 0 1 2 4 5 1 3 Sorted measuring value 0 1 1 2 3 4 5 Median  $_n = 2$

... 4 0 1 2 4 5 1 3 4 Sorted measuring value 1 1 2 3 4 4 5 Median  $_{n+1} = 3$

### 5.5.5 Dynamic Noise Rejection

This filter removes the noise of the measurement signal completely, but keeps the original bandwidth of the measurement signal.

For that purpose the signal noise is calculated dynamically and measurement changes are only transferred, if they exceed this calculated noise. Thereby at a change in direction of the measurement signal small hysteresis effects in the size of the calculated noise can occur.

## 6. Ethernet Interface

You will achieve especially high resolutions if you readout the measurements in digital form via the Ethernet interface.

For that purpose, use the web interface or a special program. MICRO-EPSILON supports you by the driver MEDAQLib, containing all commands for capaNCDT 62x8.

You can find the current driver routine including documents at:

[www.micro-epsilon.com/download](http://www.micro-epsilon.com/download)

[www.micro-epsilon.com/download/software/MEDAQLib.zip](http://www.micro-epsilon.com/download/software/MEDAQLib.zip)

### 6.1 Hardware, Interface

The data logging of all channels is synchronous.

➡ Connect the capaNCDT 62x8 to an available Ethernet interface at the PC. Use a crossover cable.

For a connection with the capaNCDT 62x8 you will require a defined IP address of the network interface card inside the PC. Go to `Control Panel\Network Connections`. Set up, if applicable, a new LAN connection. For more information, contact your network administrator.

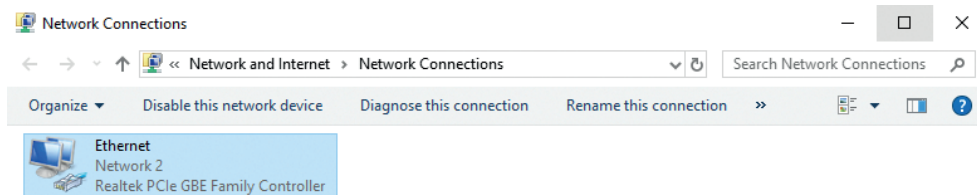

Fig. 27 LAN connection of a PC



➔ Define the following address in the properties of the LAN connection:

IP address: 169.254.168.1

Subnet mask: 255.255.0.0

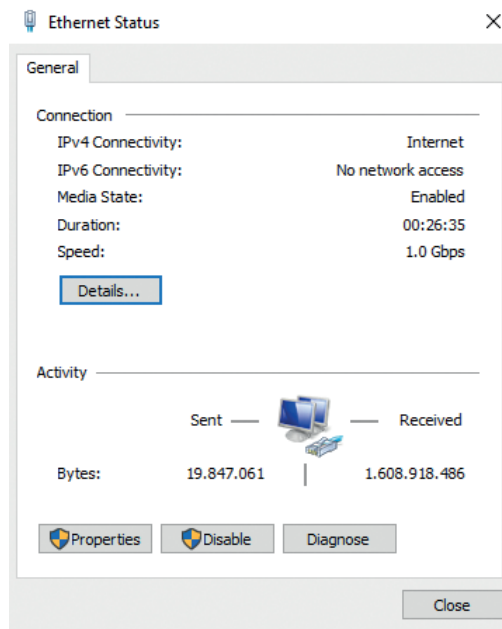

➔ Select Properties.

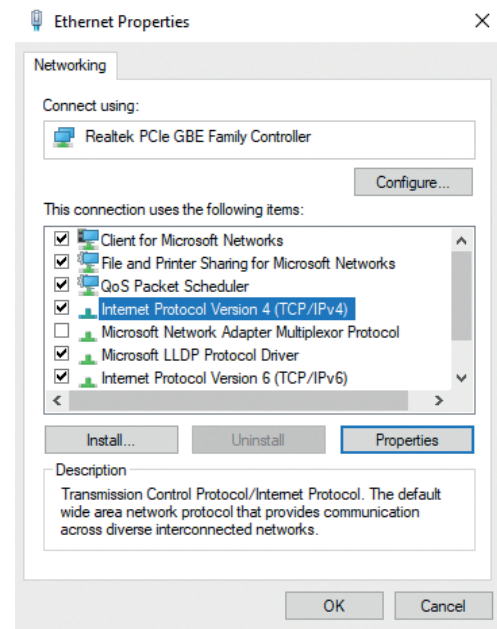

➔ Select Internet Protocol (TCP/IP) > Properties.

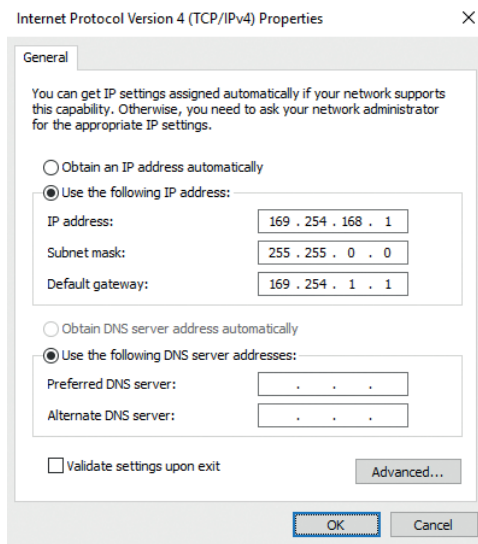

By default, the IP address of the controller is set to 169.254.168.150. Communication with the controller is done on the data port 10001 for measurement transmission. A command port (Telnet, port 23) is used for sensor commands.

The IP settings and the data port can be changed at any time:

- by using the web browser. Enter the current IP address into the address bar. Go to the menu `Settings > Digital Interfaces > Ethernet settings` to set a new IP address, activate DHCP or change the data port.
- by using software commands, [see 6.4](#).
- by using the `sensorTOOL` software.

If you activate DHCP, access to the controller via a DHCP host name is possible. The host name contains the device name and serial number. Structure: NAME\_SN e. g. DT6220\_1001.

The controller supports UPnP. If you use an operational system with activated UPnP client e. g. standard with Windows 7, the controller is listed in the explorer as a device automatically. This is helpful, if you do not know the IP address of the controller.

## 6.2 Data Format of Measuring Values

All measuring values, recorded at a time, are combined into a measuring value frame (One measuring value per channel).

Several measuring value frames are combined to a measuring value block and then transmitted together with a header as a TCP packet.

All measuring values and the header are transmitted in little-endian format.

Contents	Size	Description
Preamble	32 bit	„MEAS“ as an ASCII text
Order number	32 bit	Order number of sensor as int
Serial number	32 bit	Serial number of sensor as int
Channels (Bit field)	64 bit	Bit field, which channel available. Two bits per channel are used: „00“ = Channel is not available; „01“ = channel available. The lowest channel is on the most low-order bit -> Thereby determining the number of channels N possible.
Status	32 bit	Is not used.
Frame number M / bytes per frame	16 bit / 16 bit	One frame = one measuring value per channel
Measuring value counter	32 bit	Measuring value counter (of 1st frame)
Measuring value frame 1 [number channels N]	N * 32 bit	Measuring values all channels, starting with the lowest channel number
Measuring value frame 2 [number channels N]	N * 32 bit	„
....	...	...
Measuring value frame M [number channels N]	N * 32 bit	„

All measuring values are transmitted as Int32. The measuring value resolution is 24 bits i.e only the most low-order 24 bits of integer number are used. Hexadecimal range: 0 ... FFFFFFFF<sub>16</sub>. Exception is the mathematics function, because the result can also be greater than 24 bits.

Scaling of measuring values:

$$\text{Measurement in } \mu\text{m} = \frac{\text{Digital value (Int)}}{0xFFFFFFFF} * \text{Measuring range in } \mu\text{m}$$

Example: Measuring range sensor CS2 = 2000  $\mu\text{m}$ ; digital value = 7FFFFFFF<sub>16</sub>

Measurement = 999.99  $\mu\text{m}$

By default, the measuring values are continuously output with the set data rate via the data port.

However, there is also a trigger mode, with can be used to get the individual measuring values, [see 6.4.2](#).

## 6.3 Settings

### Operating modes:

- Continuous transmission with fixed data frequency
- Trigger mode (recall hardware trigger input or individual measuring values, [see 5.4](#)).

### Data rate:

It is possible to adjust different data rates between 2.5 Sa/s and 3.9 kSa/s. The data rate applies to all channels.

### Filter/Measuring value averaging:

The following filters are selectable:

- Moving average
- Arithmetic average (only each n<sup>th</sup> value will be output)
- Median
- Dynamic Noise Rejection

The setting for the averaging applies to all channels.

**Linearization Options:**

- Offset correction
- 2-point-linearization
- 3-point-linearization
- 5-point-linearization
- 10-point-linearization

Up to 10 linearization points can be measured for each channel. These are at 10 %, 20 %, 30 %, 40 %, 50 %, 60 %, 70 %, 80 %, 90 % and 100 % of the measurement range. That means, for example, that the sensor is adjusted to 10 % of the measurement range. This linearization point (= actual measurement at this point) is then measured and a correction curve is calculated so that the linearized measured value corresponds to the target measurement value.

Only the measurement value at 10 % of the measurement range is used for the correction of the start of the measurement range.

The correction curve for the 2-point-linearization uses data points at 10 % and 90 % of the measurement range.

The two correction curves for the 3-point-linearization use restart points at 10 % and 50 %, 50 % and 90 % of the measurement range.

The four correction curves for the 5-point-linearization use data points at 10 % and 30 %, 30 % and 50 %, 50 % and 70 %, 70 % and 90 % of the measurement range.

The nine correction curves for the 10-point-linearization use data points at 10 %, 20 %, 30 %, 40 %, 50 %, 60 %, 70 %, 80 %, 90 % and 100 % of the measurement range.

The linearization function allows an individual adjustment

- of the start of the measurement range,
- slope of the characteristic curve (Gain) and
- linearity.

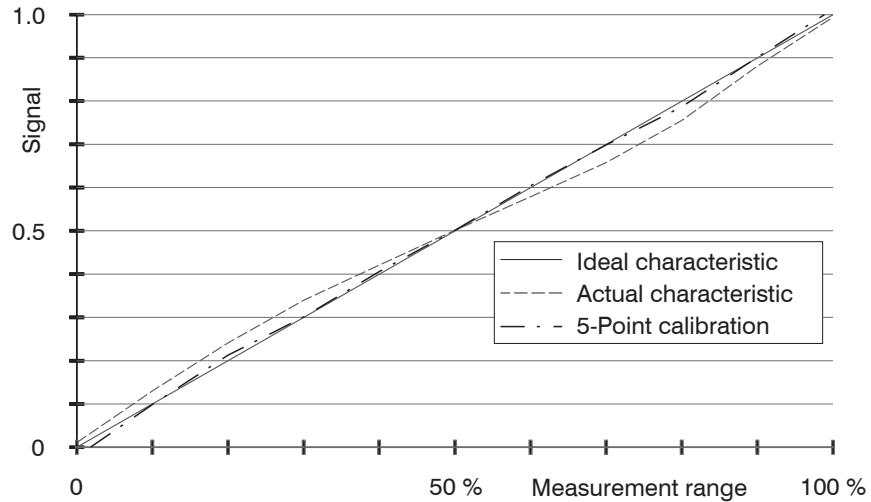

Fig. 28 Output characteristic for the measurement

**i** The software linearization affects only the values (averaging also), which are output via the Ethernet interface.

**Mathematic functions:**

For Calculation of several channels.

## 6.4 Commands

All commands are transmitted via port 23 (Telnet). Each command starts with a \$ character.

The controller ignores all characters, which are transmitted before the \$ character.

The controller immediately returns all transmitted characters back as echo.

After the response has been sent, the controller starts to send measurement values gain (applies to the operating mode "continuous transmission").

Commands are transmitted in ASCII format.

Except for the linearization types and points, the respective settings are the same for all eight channels.

A time out is reached approximately 10 seconds after the last character input.

Channel numbers are separated by a comma, channel number and a parameter belonging to the channel by a colon.

Several successive different parameters (for the command STS and VER) are separated by a semicolon.

Commands always have to end with <CR> or <CRLF>.

### 6.4.1 Data Rate (STI)

Changes the sample time in  $\mu s$  (respectively sample rate) for all channels, which are used to transmit the measuring values. The requested sample time in  $\mu s$  is sent to the controller. Because any sample time is not possible, the controller replies with the next available sampletime in  $\mu s$ . This is active from then.

	STI = Set Sample Time
Command	\$STIn<CR> Example: \$STI1200<CR>
Response	\$STIn,mOK<CRLF> Example: \$STI1200,960OK<CRLF>
Index	n = designated new sample time in $\mu s$ (TARGET)
	m = new sample time in $\mu s$ (ACTUAL)



Possible sample times	
n (in $\mu\text{s}$ )	corresponds to data rate
384000	2.6 Sa/s
192000	5.2 Sa/s
96000	10.4 Sa/s
64000	15.6 Sa/s
38400	26 Sa/s
32000	31.3 Sa/s
19200	52.1 Sa/s
16000	62.5 Sa/s
9600	104.2 Sa/s
1920	520.8 Sa/s
960	1041.7 Sa/s
480	2083.3 Sa/s
256	3906.3 Sa/s
Request sample time	
Command	<code>\$STI?&lt;CR&gt;</code>
Response	<code>\$STI?nOK&lt;CRLF&gt;</code>

### 6.4.2 Trigger Mode (TRG)

There are three possible settings regarding the trigger input, [see 5.4](#).

Irrespective of the trigger mode set, a single measured value per channel can be called up by means of a software command, [see 6.4.3](#). If the trigger mode is turned off, the capaNCDT 62x8 will send the measurement values without interruption and with the adjusted data rate.

	TRG
Command	\$TRGn<CR>
Response	\$TRGnOK<CRLF>
Index	n = 0: Continuous transmission (default setting) n = 1: Triggermode 1 (rising edge) n = 2: Triggermode 2 (high level) n = 3: Triggermode 3 (gate rising edge) ? = Request trigger mode
Request Trigger mode	
Command	\$TRG?<CR>
Response	\$TRG?nOK<CRLF>

### 6.4.3 Get Measured Data (GMD)

In the trigger mode, one measuring value is transmitted per channel.

	GMD
Command	\$GMD<CR>
Response	\$GMDOK<CRLF> + Measuring value in binary mode (format as in operating mode “continuous transmission”) via data port

#### 6.4.4 Filter, Averaging Type (AVT)

Mode of measurement averaging

	AVT
Command	\$AVTn<CR>
Response	\$AVTnOK<CRLF>
Index	n = 0: No averaging (Default setting) n = 1: Moving average n = 2: Arithmetic average (outputs only each nth measuring value) n = 3: Median n = 4: Dynamic noise rejection ? = Request averaging type
Request averaging type	
Command	\$AVT?<CR>
Response	\$AVT?nOK<CRLF>

#### 6.4.5 Filter, Averaging Number (AVN)

Number of measuring values used to calculate the average (adjustable from 2 ... 8)

	AVN
Command	\$AVNn<CR>
Response	\$AVNnOK<CRLF>
Index	n = 2 ... 8 ? = Request averaging number
Request averaging number	
Command	\$AVN?<CR>
Response	\$AVN?nOK<CRLF>

### 6.4.6 Channel Status (CHS)

Specifies in increasing order in which channels there is a module. (0 = no channel available, 1 = channel available, 2 = math function is output on this channel)

	CHS
Command	\$CHS<CR>
Response	\$CHS1,0,2,1OK<CRLF> (Example: Channel 1,3,4 available, channel 3 with math function)

### 6.4.7 Mode of Linearization (LIN)

Specifies the linearization type for each channel.

The linearization type can be set for each channel. The index m stands for channel number, the index n for the linearization type.

	LIN
Command	\$LINm:n<CR> (for example: \$LIN4:2<CR> = 2-point-linearization for channel 4)
Response	\$LINm:nOK<CRLF>
Index m (Channel number)	1 ... 4
Index n (linearization mode)	0 = no linearization (default setting) 1 = Start of measuring range 2 = 2-point-linearization 3 = 3-point-linearization 4 = 5-point-linearization 5 = 10-point-linearization
Request linearization mode	
Command	\$LIN?<CR>
Response	\$LIN?n,n,n,nOK<CRLF> (n stands for the linearization type)

### 6.4.8 Set Linearization Point (SLP)

Sets a linearization point.

Place the sensor or the target in the corresponding position. After the command has been received, the current measuring value will be recorded at this position as a linearization point and thus the constants are recalculated for the linearization.

	SLP
Command	\$SLPm:n<CR> (for example: \$LIN4:3<CR> = linearization point at 30 % of channel 4)
Response	\$SLPm:nOK<CRLF>
Index m (channel number)	1 ... 4
Index n (linearization point)	n (linearization point): 1 = linearization point at 10 % of the measuring range 2 = linearization point at 20 % of the measuring range 3 = linearization point at 30 % of the measuring range 4 = linearization point at 40 % of the measuring range 5 = linearization point at 50 % of the measuring range 6 = linearization point at 60 % of the measuring range 7 = linearization point at 70 % of the measuring range 8 = linearization point at 80 % of the measuring range 9 = linearization point at 90 % of the measuring range 10 = linearization point at 100 % of the measuring range

### 6.4.9 Get Linearization Point (GLP)

Reads out the linearization point.

The value is output hex format.

	GLP
Command	\$GLPm:n<CR> (for example: \$GLP4:3<CR> = linearization point at 30 % of channel 4)
Response	\$GLPm:n,.....OK<CRLF> (for example \$GLP5:3,A034C9OK<CRLF>)
Index	<p>m (channel number): 1...4</p> <p>n (linearization point):</p> <p>1 = linearization point at 10 % of measuring range</p> <p>2 = linearization point at 20 % of measuring range</p> <p>3 = linearization point at 30 % of measuring range</p> <p>4 = linearization point at 40 % of measuring range</p> <p>5 = linearization point at 50 % of measuring range</p> <p>6 = linearization point at 60 % of measuring range</p> <p>7 = linearization point at 70 % of measuring range</p> <p>8 = linearization point at 80 % of measuring range</p> <p>9 = linearization point at 90 % of measuring range</p> <p>10 = linearization point at 100 % of measuring range</p>

### 6.4.10 Status (STS)

Reads all settings at once.

The individual parameters are separated by a semicolon. The structure of the respective responses corresponds to those of the individual requests.

	STS
Command	\$STS<CR>
Response	\$STSSTIn;AVTn;AVNn;CHS...;TRG.OK<CRLF>

### 6.4.11 Version (VER)

Requesting the current software version including date.

	VER
Command	\$VER<CR>
Response	\$VERDT6200;V1.2a;8010079<CRLF>

### 6.4.12 Set Mathematic Function (SMF)

Sets a math function on a certain channel.

	SMF	
Command	\$SMFm:Offset,Factor1,Factor2,Factor3,Factor4<CR>	
Response	\$SMFm:Offset,Factor1,Factor2,Factor3,Factor4,OK<CRLF>	
Index	m: 1...4 (Channel number)	If a channel is selected, which is already reserved by electronics, the result of the math function is now transmitted instead of the measured value.
	Offset	24 bit offset value with prefix in hex format, at which 21 bit comply with 100 % measured value.  Numbers exceeding 21 bit are therefore greater (for example +3FFFF = complies with 200 % of the measured value).
	Factor1, ..., Factor4	Multiplication factors (including prefix), with which the measured values of channel 1 up to 8 are multiplied. The range of values of -9.9 up to +9.9 with a decimal place. Structure of factors: Prefix and a one-digit number with a decimal place, example +3.4

Example: `$SMF2:+1FFFFFF,+1.0,+0.0,+0.0,-0.3<CR>`

On channel 2 the sequent math function is output:

100 % Offset + 1 \* channel 1 - 0.3 \* channel 4

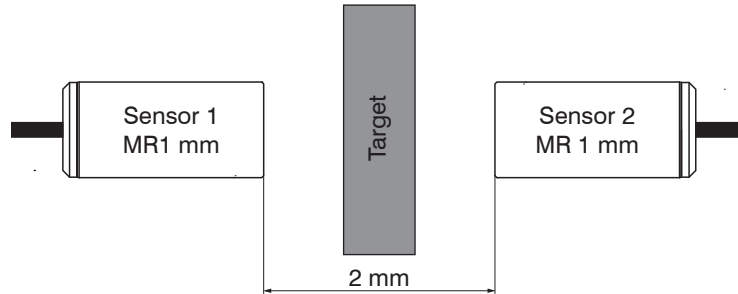

*Fig. 29 Example for thickness measurement of a target with two capacitive sensors*

Following math function is required for the above adjustment for thickness measurement of the target.

Target thickness = +200 % offset (equates to 2 mm) - 1 \* channel 1 - 1 \* channel 2

Required command:

`$SMF3:+3FFFFFF,-1.0,-1.0,+0.0,+0.0<CR>`

**i** 3 measured values can be allocated together at most, the different factors have to be +0.0 each.

If a math function is set on a channel, the channel status changes onto 2.



### 6.4.13 Get Mathematic Function (GMF)

Reads out the math function of a channel.

	GMF	
Command	\$GMFm<CR>	
Response	\$GMFm:Offset,Factor1,Factor2,Factor3,Factor4OK<CRLF>	
Index	m: 1...4 (Channel number)	If a channel is selected, which is already reserved by electronics, the result of the math function is now transmitted instead of the measured value.
	Offset	24 bit offset value with prefix in hex format, at which 21 bit comply with 100 % measured value. Numbers exceeding 21 bit are therefore greater (for example +3FFFF = complies with 200 % of the measured value).
	Factor1, ..., Factor4	Multiplication factors (including prefix), with which the measured values of channel 1 up to 4 are multiplied. The range of values of -9.9 up to +9.9 with a decimal place. Structure of factors: Prefix and a one-digit number with a decimal place. Example +3.4.

### 6.4.14 Clear Mathematic Function (CMF)

Deletes the math function on a channel.

	CMF	
Command	\$CMFm<CR>	
Response	\$CMFmOK<CRLF>	
Index	m: 1...4 (Channel number)	

### 6.4.15 Ethernet Settings (IPS)

Changes the IP settings of the controller.

	IPS
Command	\$IPSm,<IPAddress>,<SubnetAddress>,<GatewayAddress> <CR>
Example	\$IPSO,169.254.168.150,255.255.0.0,169.254.168.1<CR>
Response	\$IPSm,<IPAddress>,<SubnetAddress>,<GatewayAddress>OK<CRLF>
Index	m = 0: static IP address m = 1: activates DHCP* * If DHCP is active, no IP subnet- and gateway address has to be transmitted.
Request settings	
Command	\$IPS?
Response	\$IPS? m,<IPAddress>,<SubnetAddress>,<GatewayAddress>OK<CRLF>

### 6.4.16 Change between Ethernet and EtherCAT (IFC = Interface)

Command switches between Ethernet and EtherCAT interface. Effective only, if the switch `Ethernet/ EtherCAT` is in the position `ECAT/Auto`. Otherwise always the Ethernet interface is active. The new interface is activated after a restart of the controller.

	IFC
Command	\$IFCm<CR> Example: \$IFC1<CR>
Response	\$IFCmOK<CRLF>
Index	m = 0: Ethernet m = 1: EtherCAT
Request	
Command	\$IFC?
Response	\$IFC?mOK<CRLF>

#### 6.4.17 Query Data Port (GDP)

Queries the port number of the data port.

Command	\$GDP<CR>
Response	\$GDP<Port number>OK<CRLF> Example: \$GDP10001OK<CRLF>

#### 6.4.18 Set Data Port (SDP)

Sets the port number of the data port. Range: 1024 ...65535.

Command	\$SDP<Portnumber><CR> Example: \$SDP10001OK<CR>
Response	\$SDP<Portnumber>OK<CRLF>

#### 6.4.19 Access Channel Information (CHI)

Reads channel-specific information (e.g. serial number of the display board).

Command	\$CHIm<CR>
Response	\$CHIm:ANO...,NAM...,SNO...,OFS...,RNG...,UNT...,DTY...OK<CRLF>
Index	<p>m (Channel number): 1 - 4            ANO = Article number            NAM = Name            SNO = Serial number            OFS = Measuring range offset            RNG = Measuring range            UNT = Unit of measuring range (e.g. <math>\mu\text{m}</math>)            DTY = Data type of measuring value (1 = measuring value as INT,            0 = no measuring value)</p>

#### 6.4.20 Access Controller Information (COI)

Reads information of the controller (e.g. serial number).

Command	\$COI<CR>
Response	\$COIANO...,NAM...,SNO...,OPT...,VER...OK<CRLF>
Index	ANO = Article number NAM = Name SNO = Serial number OPT = Option VER = Firmware version

#### 6.4.21 Login for Web Interface (LGI)

Changes the user level for the web interface on `professional`.

Command	\$LGI<Password> <CR>
Response	\$LGI<Password> <OK>CRLF
Index	Password = Password of the device. When delivered, no password is assigned. The field can remain empty.

#### 6.4.22 Logout for Web Interface (LGO)

Changes the user level for the web interface on `user`.

Command	\$LGO<CR>
Response	\$LGOOK<CRLF>

### 6.4.23 Change Password (PWD)

Changes the password of the device (required for the web interface and the `sensorTOOL`).

Command	\$PWD<oldpassword>,<newpassword>,<newpassword><CR>
Response	\$PWD<oldpassword>,<newpassword>,<newpassword>OK<CRLF> A password can be from 0-16 characters and must contain only letters and numbers. When delivered, no password is assigned. The field can remain empty/blank.

### 6.4.24 Change Language for the Web Interface (LNG)

Changes the language of the web interface.

Command	\$LNGn<CR>
Response	\$LNGnOK<CRLF>
Index	0 = System 1 = English 2 = German

### 6.4.25 Write Measuring Range Information in Channel (MRA)

Changes the measuring range information of a channel (e.g. in case of a sensor change). This information is e.g. required for the correct scaling of the measuring values in the web interface. The value is specified in  $\mu\text{m}$ .

This is only an information value, what means, the actual measuring range of a sensor is not changed by changing the value.

Command	\$MRAm:<Range in $\mu\text{m}$ ><CR> (Example: \$MRA2:2000<CR> sets the measuring range of channel 2 to 2000 $\mu\text{m}$ )
Response	\$MRAm:<Range in $\mu\text{m}$ >OK<CRLF>
Index	m (Channel number): 1 - 4

#### 6.4.26 Set Analog Filter (ALP)

Enables/Disables a low pass filter with 20 Hz limit frequency on analog output

Command	\$ALPn<CR>
Response	\$ALPnOK<CRLF>
Index	0 = Low pass filter not active 1 = Low pass filter is active
Request	\$ALP?
Response	\$ALP?nOK<CRLF>

#### 6.4.27 Default Messages

- Unknown command: (ECHO) + \$UNKNOWN COMMAND<CRLF>
- Wrong parameter after command: (ECHO) + \$WRONG PARAMETER<CRLF>
- Timeout (approximately 15 s after last input) (ECHO) + \$TIMEOUT<CRLF>
- Wrong password: \$WRONG PASSWORD<CRLF>

## 6.5 Operation Using Ethernet



Dynamic web pages are generated in the controller which contain the current settings of the controller and the peripherals. Operation is only possible while there is an Ethernet connection to the controller.

### 6.5.1 Requirements

You need a web browser with HTML5 support (e.g. Mozilla Firefox  $\geq 3.5$  or Internet Explorer  $\geq 10$ ) on a PC with a network connection. To support a basic first commissioning of the controller, the controller is set to a direct connection.

If you have configured your browser to access the internet via a proxy server, in the browser settings you will need to add the IP address of the controller to the list of addresses which should not be routed through the proxy server. The MAC address of the unit can be found on the nameplate of the controller.

“Javascript” must be enabled in the browser so that measurement results can be displayed graphically.

Direct connection to PC, controller with static IP (Factory setting)		Network
PC with static IP	PC with DHCP	Controller with dynamic IP, PC with DHCP
<p>➡ Connect the controller to a PC using a direct Ethernet connection (LAN). Use a LAN cable with RJ-45 connectors for this.</p>		<p>➡ Connect the controller to a switch using a direct Ethernet connection (LAN). Use a LAN cable with RJ-45 connectors for this.</p>
<p>➡ Now start the <code>sensorTOOL</code> program.</p> <p>➡ Click the button . Select the designated controller from the list. In order to change the address settings, click the button <code>Change IP...</code></p> <ul style="list-style-type: none"> <li>• Address type: static IP address</li> <li>• IP address: 169.254.168.150 <sup>1</sup></li> <li>• Subnet mask: 255.255.0.0</li> </ul> <p>➡ Click the button <code>Apply</code> to transmit the changes to the controller.</p> <p>➡ Click the button <code>Open WebPage</code> to connect the controller with your default browser.</p> <p>1) Requires that the LAN connection on the PC uses, for example, the following IP address: 169.254.168.1.</p>	<p>Wait until Windows has established a network connection (Connection with limited connectivity).</p> <p>➡ Now start the <code>sensorTOOL</code> program.</p> <p>➡ Click the button . Select the designated controller from the list.</p> <p>➡ Click the button <code>Open WebPage</code> to connect the controller with your default browser.</p>	<p>➡ Enter the controller in the DHCP / register the controller in your IT department.</p> <p>The controller gets assigned an IP address from your DHCP server. You can check this IP address with the <code>sensorTOOL</code> program.</p> <p>➡ Now start the <code>sensorTOOL</code> program.</p> <p>➡ Click the button . Select the designated controller from the list.</p> <p>➡ Click the button <code>Open WebPage</code> to connect the controller with your default browser.</p> <p>Alternatively: If DHCP is used and the DHCP server is linked to the DNS server, access to the controller via a host name of the structure “DT6230_&lt;serial_number&gt;” is possible.</p> <p>➡ Start a web browser on your PC. To achieve a controller with the serial number “01234567”, type in the address bar on your browser “DT6230_01234567”.</p>
<p>Interactive web pages for setting the controller and peripherals are now shown in the web browser.</p>		

The `sensorTOOL` program is available online at <https://www.micro-epsilon.com/download/software/sensorTool.exe>.



## 6.5.2 Access via Web Interface

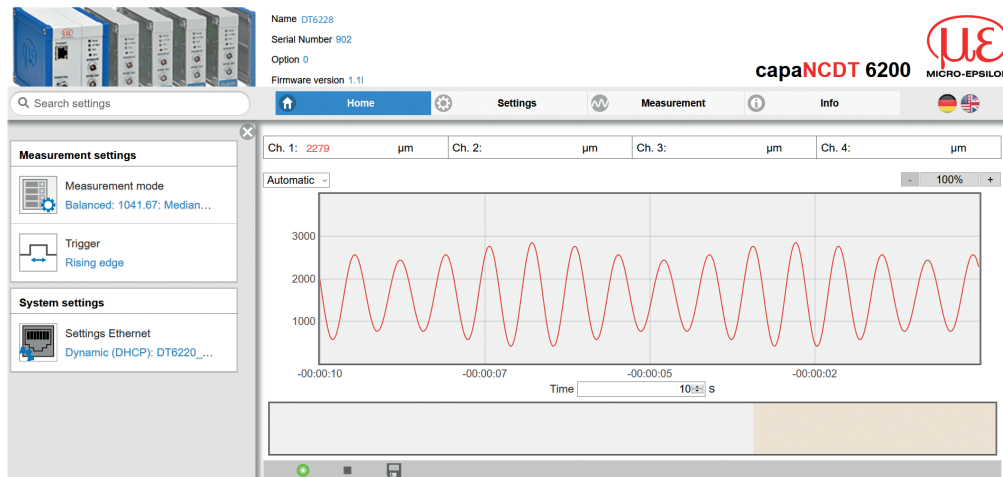

Fig. 30 First interactive web page after calling the IP address

Use the upper navigation bar to access additional features (e. g. Settings etc.).

All settings on the web page are applied immediately in the controller.

Parallel operation with web interface and Telnet commands is possible; the last setting applies.

The appearance of the web pages may vary depending on functions and peripherals. Each page contains parameter descriptions and tips on completing the controller.

### 6.5.3 Operating Menu, Set Controller Parameter

You can program the capaNCDT 62x8 at the same time in two different kinds:

- Using a web browser via the sensor web interface
- With ASCII command set and terminal program via Ethernet (Telnet)

## 6.6 Channel n

### 6.6.1 Channel Information, Measuring Range

➤ Menu `Settings > Channel n > Channel information`.

The measuring ranges of the connected sensors must be entered manually. Do not forget to enter the new range after changing a sensor.

Data channel	1 / 2 / 3 / 4	Value	Value range 0 ... 1000000 $\mu\text{m}$
--------------	---------------	-------	---

### 6.6.2 Linearization

A linearization of a measuring channel (physical demodulator module) may be necessary, if, for example, the target geometry is changed. Selection of a linearization type depends on how many data points the correction curve should use.

**i** The measuring device requires a run-in period of approximately 15 minutes.

Measuring channel	1 / 2 / 3 / 4	Linearization type	No linearization / Offset / 2-point / 3-point / 5-point / 10-point
-------------------	---------------	--------------------	--

The sequence, with that the linearization points are measured, doesn't play a role.

#### Example: Procedure for a 3 point linearization:

- Select the designated measuring channel.
- Select a 3-point linearization type.
- Adjust the target to 10 % of the measuring range to the sensor.

 Grey shaded fields require a selection.

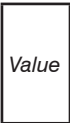
 Dark-bordered fields require you to specify a value.

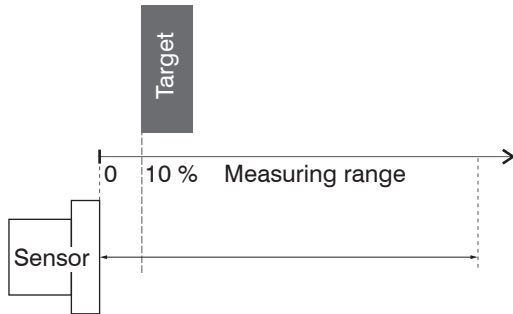

- Click on the `Reset` button in web interface in the line 10 %
- Adjust the target to 50 % of the measuring range to the sensor.

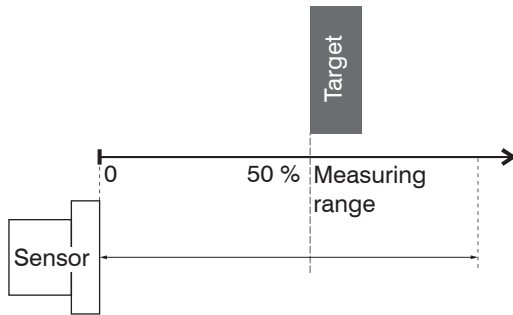

- Click on the `Reset` button in web interface in the line 50 %
- Adjust the target to 90 % of the measuring range to the sensor.

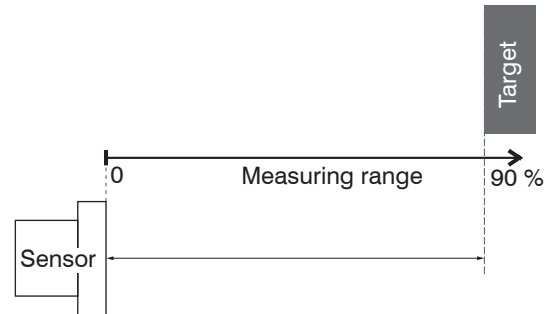

- Click on the `Reset` button in web interface in the line 90 %
- The program will calculate the correction curve from the three data points.

### 6.6.3 Math Function

**Math function**

Offset (µm)

+ Measurement channel 1 ×

+ Measurement channel 2 ×

+ Measurement channel 3 ×

+ Measurement channel 4 ×

Set math function

Clear math function

This function enables the scaling of a measuring channel and the mathematical combination of individual channels.

**Formula:** Data channel = Offset + factor measurement channel 1 + factor measurement channel 2 + factor measurement channel 3 + factor measurement channel 4.

Data channel = digital values

Measuring channel = analog value of a demodulator module

Data channel	1 / 2 / 3 / 4	Offset	<i>Value</i>	Value range ±8-point MR max.
		Factor measuring channel	<i>Value</i>	Value range -9,9 ... +9,9

Grey shaded fields require a selection.

*Value* Dark-bordered fields require you to specify a value.

## 6.7 Measurement Settings

### 6.7.1 Measurement Mode

➤ Menu Settings > Measurement settings > Measurement mode

**Measurement mode**

Measurement mode

**Low noise** ▼

Data rate (Hz)

**104.17** ▼

Filter type

**Median** ▼

Filter width

**7** ▼

Analog low pass filter

**Active** ▼

High speed	<i>data rate: 3906.25 Hz, filter type: Off, analog low pass: inactive</i>
Balanced	<i>data rate: 1041.67 Hz, filter type: Median, filter width: 3, analog low pass: inactive</i>
Low noise	<i>data rate: 104.17 Hz, filter type: Median, filter width: 7, analog low pass: active</i>
User defined	

#### 6.7.1.1 Data Rate

Data Rate	2.6 / 5.21 / 10.42 / 15.63 / 26.04 / 31.25 / 52.08 / 62.5 / 104.17 / 520.83 / 1041.67 / 2083.33 / 3906.25 Sa/s	Instructs the sensor about the frequency, with which data are output via the Ethernet interface.
-----------	--	--

Grey shaded fields require a selection.

Dark-bordered fields require you to specify a value.

### 6.7.1.2 Filter type / Averaging

Filter type	No Averaging			
	Moving average	Value	Filter width 2 / 3 / 4 / 5 / 6 / 7 / 8	<i>Designation of averaging type. Averaging number indicates, about how many current measuring values should be averaged in the controller, before a new measuring value is output.</i>
	Arithmetic mean	Value		
	Median	Value		
	Dynamic noise rejection			

It is recommended, to use averaging for statical measuring or slowly changing measuring values. An averaging reduces noise or suppresses distortions in measuring values.

### 6.7.1.3 Analog Low Pass Filter

Filter	active / inactive	<i>Switches the deep pass filter with 20 Hz limit frequency on analog output</i>
--------	-------------------	--

### 6.7.2 Trigger Mode

➡ Menu Settings > Measurement settings > Trigger

This menu item determines the trigger behavior. The triggering is released by an external electrical signal, [see 4.7.2](#) or by the command \$ GMD, [see 6.4.3](#).

If the trigger mode is turned off, the capaNCDT 62x8 will send the measuring values without interruption and with the adjusted data rate.

Trigger	Rising edge	<i>A measuring value is output per edge.</i>
	Level high	<i>Level triggering. Measuring value output, as long as the level is active.</i>
	Rising edge (gate)	<i>Starts resp. stops the measuring value output alternatively.</i>
	No trigger	<i>Controller sends measuring values continuously.</i>

Grey shaded fields require a selection.

Value fields require you to specify a value.

## 6.8 System Settings

### 6.8.1 Language Selection

The web interface promotes the units millimeter (mm) when displaying measuring results. You can choose German, English, Chinese, Japanese, Korean or the preset browser language in the web interface. You can also change the language in the menu bar.

### 6.8.2 Login, Changing User Level

➡ Menu Settings > System settings > Switch user

In the delivery state, the controller is set to Expert level.

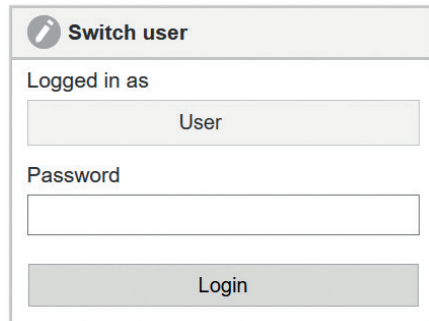

Change to the User level by clicking the `Logout` button. Enter the password into the `Password` field, and confirm with `Login` in order to switch to the `Expert` user level. In `Professional` mode, you can use the system settings to assign a user-defined password, see 6.8.3.

Fig. 31 Changing to professional level

The current user level remains after leaving the web interface or restarting the controller.

The following functions are accessible for the user:

	User	Professional
Password required	no	yes
View settings	yes	yes
Change settings, linearization, analog output, password	no	yes
Start measuring	yes	yes
Scaling diagrams	yes	yes

Fig. 32 Permissions within the user hierarchy

### 6.8.3 Password

Assigning passwords prevents unauthorized changes to controller settings. In the delivery state, no password is deposited in the controller.

**i** A firmware update will not change the custom password.

After the controller has been configured, you should enable password protection.

➔ Change to the menu `Settings > System settings > Change password`.

Password	Value	<i>All passwords are case-sensitive. Letters and numbers are allowed, but special characters are not permitted. A password consists of max. 16 characters.</i>
----------	-------	--

With the first-time assignment of a password the `Old Password` field remains free.

### 6.8.4 Ethernet Settings

➔ Menu `Settings > System settings > Settings Ethernet`.

The IP address of the controller is factory-set to 169.254.168.150. Communication with the controller is performed via a data port (factory-set 10001) for measurement data transmission.

You can change the IP settings and the data port at any time:

- using the web browser,
- using the `sensorTOOL` Software.

Address type	static IP address / Dynamic (DHCP)	<i>When using a static IP address it is necessary to enter the values for the IP address, netmask and gateway; this is not required when DHCP is used. When DHCP is activated, the controller is accessible in the network under its DHCP Host name. It contains the name and serial number and is unchangeable, see Chap. 6.5.1. With DHCP it may be necessary to enable the controller MAC address.</i>	
IP address	Value		
Netmask	Value		
Gateway	Value		
MAC address	Value		
UUID	Value		
Data port	Value		
			<i>Setting the port on the measurement value server</i>

Grey shaded fields require a selection.

Dark-bordered fields require you to specify a value.



### 6.8.5 Import, Export

➤ Menu Settings > System settings > Manage settings

Here you can export all controller settings in a file or reimport them from a file.

The Export feature generates a text file which you can either store or display with an editor.

Sensor settings e. g. Measuring range, linearization settings

Controller settings e. g. Measurement settings, math function, system settings (e. g. language)

Ethernet settings e. g. Address type (static, DHCP), IP address, operating mode after start

When importing settings, consider if you want to replace the current controller and/or Ethernet settings.

➤ Choose the desired import option in the `settings` section.

## 6.9 Firmware Update

The controller has a firmware update function. We recommend to always use the latest firmware version. You can find the latest firmware version on our website and it can be installed with the attached Firmware Update Tool.

## 7. EtherCAT Interface

### 7.1 Introduction

The EtherCAT interface allows a fast transfer of measured values. The controller supports CANopen over EtherCAT (CoE).

Service Data Objects SDO: All parameters of the controller can thus be read or modified.

Process Data Objects PDO: A PDO telegram is used for real-time transmission of measured values. Individual objects are not addressed. The content of the previously selected data is transmitted.

The displacement values are transmitted as 32 bit Float values.

### 7.2 Change Interface

You can not change directly to the EtherCAT interface through the web interface or command. Restart your controller to do this. Keep in mind also that the setting of the EtherCAT switch is in the correct position, see Fig. 33, see 5.5.3.

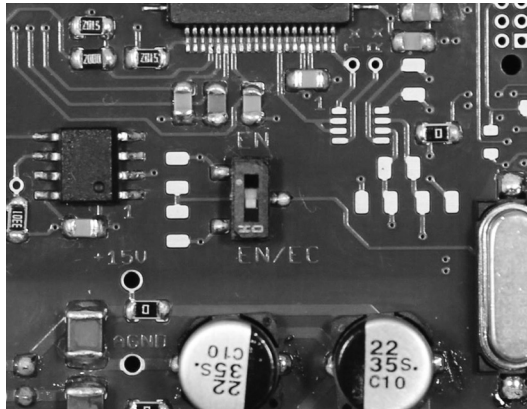

Fig. 33 Switch to change the interface

Switch position	Meaning
EN (Ethernet)	Regardless to the software setting always the Ethernet interface is active.
EN/EC (Ethernet/EtherCAT)	Active interface, which is set via the web interface or command.

A change from the EtherCAT interface back to the Ethernet interface is possible with the hardware switch on the DT6238 basic unit or via the corresponding CoE Object. In both cases, then a restart of the controller is required.

To integrate the EtherCAT interface e.g. within TwinCAT an ESI-file is supplied.

You will find further instructions in the appendix, [see A 6](#).

## 8. Measurement

With the capaNCDT either the deflection or the compensation method of measurement can be applied.

- **Deflection method** for fast events and tolerance monitoring:

Put the zero point in the centre of the measuring range, the output signal is then in proportion to the distance.

Fast events are displayed on a suitable external recorder (oscilloscope, recorder, transient recorder).

- **Compensation method** for constant or slowly changing distances.

Compensation is carried out with the “zero” potentiometer until the output signal is 0 Volt. Sensitivity is not affected by doing this.

## 9. Operation and Maintenance

Please take care of the following:

- ➡ Make sure that the sensor surface is always clean.
- ➡ Switch off the power supply before cleaning.
- ➡ Clean with a damp cloth; then rub the sensor surface dry.

Changing the target or very long operating times can lead to slight reductions in the operating quality (long term errors). These can be eliminated by recalibration.



- ➡ Disconnect the power supply before touching the sensor surface.

- > Static discharge
- > Danger of injury

If the controller, the sensor or the sensor cable is defective, please send us the affected parts for repair or exchange. If the cause of a fault cannot be clearly identified, please send us the entire measuring system to:

MICRO-EPSILON MESSTECHNIK  
GmbH & Co. KG  
Koenigbacher Str. 15  
94496 Ortenburg / Germany

Tel. +49 (0) 8542 / 168-0  
Fax +49 (0) 8542 / 168-90  
info@micro-epsilon.com  
www.micro-epsilon.com

## 10. Disclaimer

All components of the device have been checked and tested for functionality in the factory. However, should any defects occur despite careful quality control, these shall be reported immediately to MICRO-EPSILON or to your distributor / retailer.

MICRO-EPSILON undertakes no liability whatsoever for damage, loss or costs caused by or related in any way to the product, in particular consequential damage, e.g., due to

- non-observance of these instructions/this manual,
- improper use or improper handling (in particular due to improper installation, commissioning, operation and maintenance) of the product,
- repairs or modifications by third parties,
- the use of force or other handling by unqualified persons.

This limitation of liability also applies to defects resulting from normal wear and tear (e.g., to wearing parts) and in the event of non-compliance with the specified maintenance intervals (if applicable).

MICRO-EPSILON is exclusively responsible for repairs. It is not permitted to make unauthorized structural and / or technical modifications or alterations to the product. In the interest of further development, MICRO-EPSILON reserves the right to modify the design.

In addition, the General Terms of Business of MICRO-EPSILON shall apply, which can be accessed under Legal details | Micro-Epsilon <https://www.micro-epsilon.com/impressum/>

## 11. Decommissioning, Disposal

In order to avoid the release of environmentally harmful substances and to ensure the reuse of valuable raw materials, we draw your attention to the following regulations and obligations:

- Remove all cables from the sensor and/or controller.
- Dispose of the sensor and/or the controller, its components and accessories, as well as the packaging materials in compliance with the applicable country-specific waste treatment and disposal regulations of the region of use.
- You are obliged to comply with all relevant national laws and regulations.

For Germany / the EU, the following (disposal) instructions apply in particular:

- Waste equipment marked with a crossed garbage can must not be disposed of with normal industrial waste (e.g. residual waste can or the yellow recycling bin) and must be disposed of separately. This avoids hazards to the environment due to incorrect disposal and ensures proper recycling of the old appliances.





- A list of national laws and contacts in the EU member states can be found at [https://ec.europa.eu/environment/topics/waste-and-recycling/waste-electrical-and-electronic-equipment-weee\\_en](https://ec.europa.eu/environment/topics/waste-and-recycling/waste-electrical-and-electronic-equipment-weee_en). Here you can inform yourself about the respective national collection and return points.
- Old devices can also be returned for disposal to MICRO-EPSILON at the address given in the imprint at <https://www.micro-epsilon.de/impressum/>.
- We would like to point out that you are responsible for deleting the measurement-specific and personal data on the old devices to be disposed of.
- Under the registration number WEEE-Reg.-Nr. DE28605721, we are registered at the foundation Elektro-Altgeräte Register, Nordost-park 72, 90411 Nuremberg, as a manufacturer of electrical and/or electronic equipment.

## Appendix

### A 1 Accessories, Service

#### A 1.1 Conversion Kit

The conversion kit is contained in the scope of supply, [see 3.1](#).

Ground terminal		$\varnothing$ 4,3 mm (.17.3 dia.)
Mounting clamps for mounting on DIN-rail		20 x 0.8 mm/ CK75G hardened/ plated

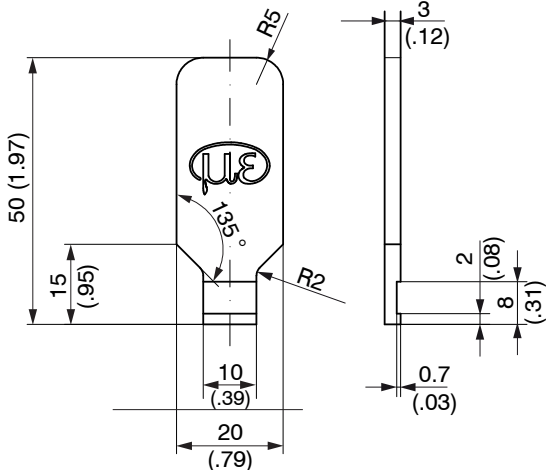
<p>Mounting plate for DT62x8</p>		<p>Aluminum / powder-coated</p>
<p>Plugging off assistance for connector</p>		

Dimensions in mm (inches), not to scale

Further more, the conversion kit contains sleeve nuts, threaded rods in different lengths and screws.



**A 1.2 PC6200-3/4**

The PC6200-3/4 is contained in the scope of supply, [see 3.1](#).

<p>PC6200-3/4</p>		<p>Power supply and trigger cable, 3 m long</p>
-------------------	---	---

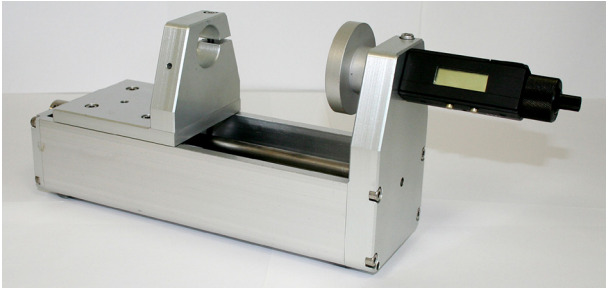

**A 1.3 Optional Accessories**

<p>MC2.5</p>		<p>Micrometer calibration fixture, setting range 0 - 2.5 mm, reading 0.1 <math>\mu\text{m}</math>, for sensors CS005 to CS2</p>
<p>MC25D</p>		<p>Digital micrometer calibration fixture, setting range 0 - 25 mm, adjustable zero point for all sensors</p>

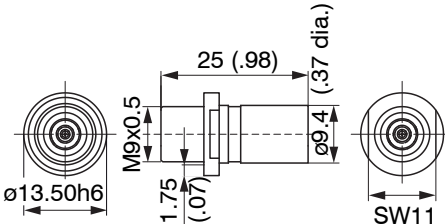
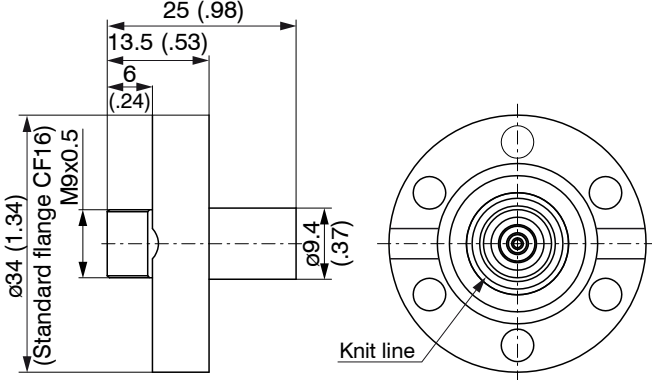
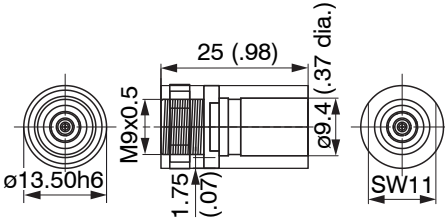
<p>SWH.OS.650.CTMSV</p>		<p>Vacuum feed through,              Max. leak rate <math>1 \times 10^{-7}</math> mbar · l s<sup>-1</sup>              Compatible with connector type B</p>
-------------------------	--	---

<p>UHV/B</p>		<p>Vacuum feed through triax weldable              Max. leak rate <math>1 \times 10^{-9}</math> mbar · l s<sup>-1</sup>              Compatible with connector type B</p>
		<p>Vacuum feed through triax with CF16 flange              Max. leak rate <math>1 \times 10^{-9}</math> mbar · l s<sup>-1</sup>              Compatible with connector type B</p>
		<p>Vacuum feed through triax screwable              Max. leak rate <math>1 \times 10^{-9}</math> mbar · l s<sup>-1</sup>              Compatible with connector type B</p>

All vacuum feed throughs are compatible to the connectors type B, [see 4.3](#).

SCACx/4	 A coiled beige cable with a grey connector on one end and a multi-colored wire bundle on the other. A small white label with 'SCAC3/4' is visible on the cable.	Signal output cable analog, x m long (necessarily for multi-channel operation)
SC6000-x	 A coiled beige cable with two grey connectors at both ends. The cable has some text printed on it, including 'PULS' and 'SC6000-x'.	Synchronization cable
PS2020	 A blue DIN-rail power supply unit with a black top cover. The front panel features a terminal block, a yellow terminal, and a red terminal. The brand name 'PULS' is printed on the front.	Power supply for mounting on DIN-rail input 230 VAC (115 VAC) output 24 VDC / 2.5 A; L/W/H 120 x 120 x 40 mm

#### A 1.4 Service

Function and linearity check-out, inclusive 11-point protocol with graphic and post-calibration.

## A 2 Factory Setting

### Analog:

- Zero-poti = Off (right-stop)
- LP filter 20 Hz = Off

### Digital:

- Data rate = 3906 Sa/s
- Filter = Off
- Linearization = Off
- Trigger mode = Off
- Math functions = Off
- IP address = Static IP  
(169.254.168.150)
- Data port = 10001

### A 3 Tilt Angle Influence on the Capacitive Sensor

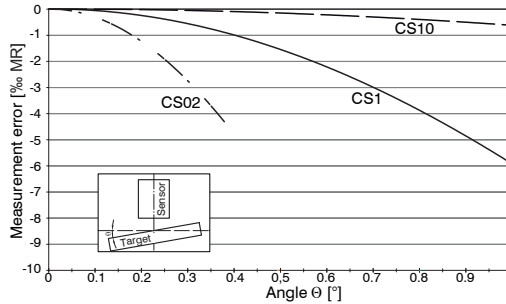

Fig. 34 Example of measuring range deviation in the case of a sensor distance of 10 % of the measuring range

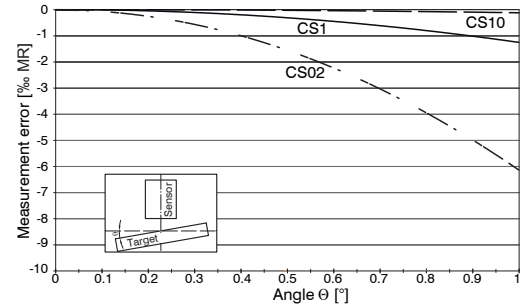

Fig. 35 Example of measuring range deviation in the case of a sensor distance of 50 % of the measuring range

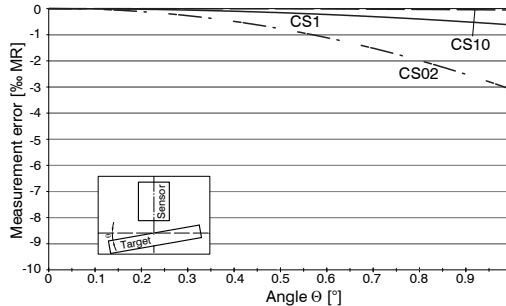

Fig. 36 Example of measuring range deviation in the case of a sensor distance of 100 % of the measuring range

**i** Figures give an influence example shown on the sensors CS02/CS1 and CS10 in the case of different sensor distances to the target. As this results from internal simulations and calculations, please request for detailed information.

### A 4 Measurement on Narrow Targets

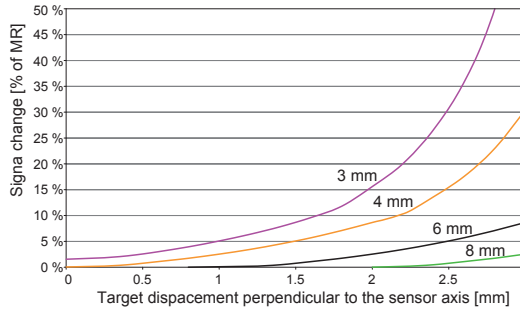

Fig. 37 Example of measuring range deviation in the case of a sensor distance of 10 % of the measuring range

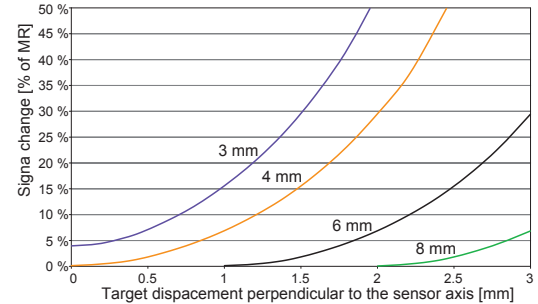

Fig. 38 Example of measuring range deviation in the case of a sensor distance of 50 % of the measuring range

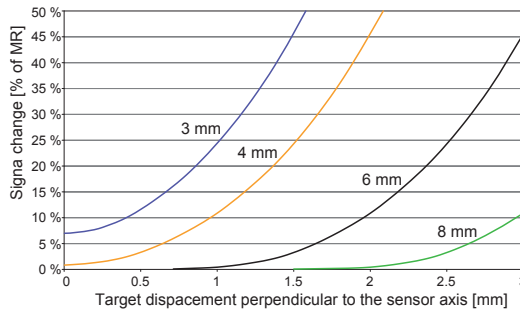

Fig. 39 Example of measuring range deviation in the case of a sensor distance of 100 % of the measuring range

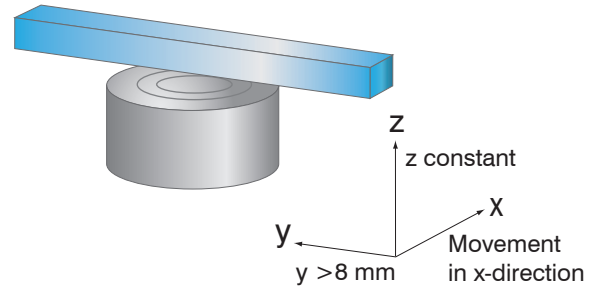

Fig. 40 Signal change in the case of displacement of thin targets in the opposite direction to the measurement direction

Figures give an influence example shown on the sensors CS05 in the case of different sensor distances to the target as well as target widths. As this results from internal simulations and calculations, please request for detailed information.

## A 5 Measurements on Balls and Shafts

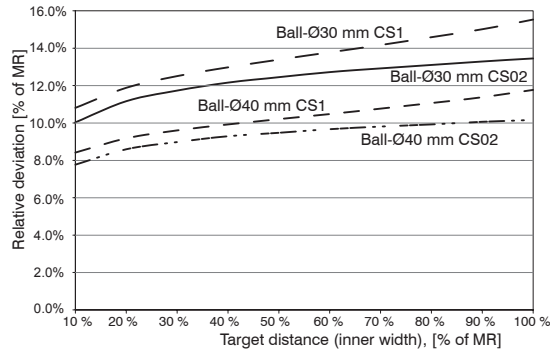

Fig. 41 Measuring value deviation in the case of measurement on ball-shaped targets

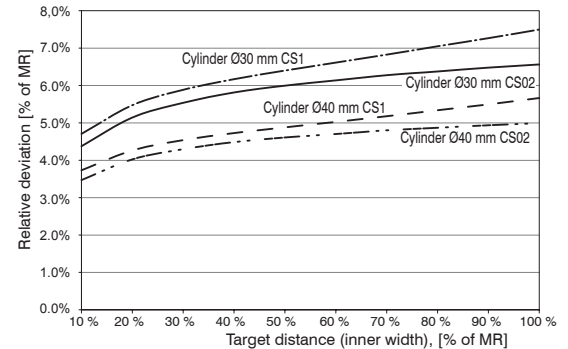

Fig. 42 Measuring value deviation in the case of measurement on cylindrical targets

Figures give an influence example shown on the sensors CS02 and CS1 in the case of different sensor distances to the target as well as target diameters. As this results from internal simulations and calculations, please request for detailed information.



## A 6 EtherCAT Documentation

EtherCAT® is, from the Ethernet viewpoint, a single, large Ethernet station that transmits and receives Ethernet telegrams. Such an EtherCAT system consists of an EtherCAT master and up to 65535 EtherCAT slaves. Master and slaves communicate via a standard Ethernet wiring. On-the-fly processing hardware is used in each slave. The incoming Ethernet frames are directly processed by the hardware. Relevant data are extracted or added from the frame. The frame is subsequently forwarded to the next EtherCAT® slave device. The completely processed frame is sent back from the last slave device. Various protocols can be used in the application level. CANopen over EtherCAT technology (CoE) is supported here. In the CANopen protocol, an object tree with Service Data Objects (SDO) and Process Data Objects (PDO) is used to manage the data. Further information can be obtained from ® Technology Group ([www.ethercat.org](http://www.ethercat.org)) or Beckhoff GmbH, ([www.beckhoff.com](http://www.beckhoff.com)).

### A 6.1 Preamble

#### A 6.1.1 Structure of EtherCAT®-Frames

The transfer of data occurs in Ethernet frames with a special Ether type (0x88A4). Such an EtherCAT® frame consists of one or several EtherCAT® telegrams, each of which is addressed to individual slaves / storage areas. The telegrams are either transmitted directly in the data area of the Ethernet frame or in the data area of the UDP datagram. An EtherCAT® telegram consists of an EtherCAT® header, the data area and the work counter (WC). The work counter is incremented by each addressed EtherCAT® slave that exchanged the corresponding data.

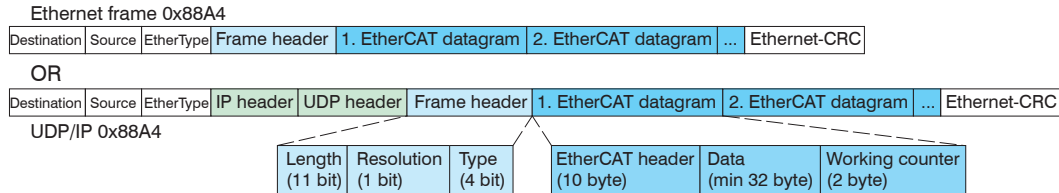

Fig. 43 Setup of EtherCAT frames

### A 6.1.2 EtherCAT® Services

In EtherCAT® services for the reading and writing of data are specified in the physical memory of the slave hardware. The following EtherCAT® services are supported by the slave hardware:

- APRD (Autoincrement physical read, Reading of a physical area with auto-increment addressing)
- APWR (Autoincrement physical write, Writing of a physical area with auto-increment addressing)
- APRW (Autoincrement physical read write, Reading and writing of a physical area with auto-increment addressing)
- FPRD (Configured address read, Reading of a physical area with fixed addressing)
- FPWR (Configured address write, Writing of a physical area with fixed addressing)
- FPRW (Configured address read write, Reading and writing of a physical area with fixed addressing)
- BRD (Broadcast Read, Broadcast Reading of a physical area for all slaves)
- BWR (Broadcast Write, Broadcast Writing of a physical area for all slaves)
- LRD (Logical read, Reading of a logical storage area)
- LWR (Logical write, Writing of a logical storage area)
- LRW (Logical read write, Reading and writing of a logical storage area)
- ARMW (Auto increment physical read multiple write, Reading of a physical area with auto-increment addressing, multiple writing)
- FRMW (Configured address read multiple write, Reading of a physical area with fixed addressing, multiple writing)

### A 6.1.3 Addressing and FMMUs

In order to address a slave in the EtherCAT® system, various methods from the master can be used. The DT6230 supports as full slave:

- Position addressing  
The slave device is addressed via its physical position in the EtherCAT® segment.  
The services used for this are APRD, APWR, APRW.
- Node addressing  
The slave device is addressed via a configured node address, which was assigned by the master during the commissioning phase.  
The services used for this are FPRD, FPWR and FPRW.
- Logical addressing  
The slaves are not addressed individually; instead, a segment of the segment-wide logical 4-GB address is addressed. This segment can be used by a number of slaves.  
The services used for this are LRD, LWR and LRW.

The local assignment of physical slave memory addresses and logical segment-wide addresses is implemented via the field bus Memory Management Units (FMMUs). The configuration of the slave FMMUs is implemented by the master. The FMMU configuration contains a start address of the physical memory in the slave, a logical start address in the global address space, length and type of the data, as well as the direction (input or output) of the process data.

### A 6.1.4 Sync Manager

Sync Managers serve the data consistency during the data exchange between EtherCAT® master and slaves. Each Sync Manager channel defines an area of the application memory. The DT6230 has four channels:

- Sync-Manager-Channel 0: Sync Manager 0 is used for mailbox write transfers (mailbox from master to slave).
- Sync-Manager-Channel 1: Sync Manager 1 is used for mailbox read transfers (mailbox from slave to master).
- Sync-Manager-Channel 2: Sync Manager 2 is usually used for process output data. Not used in the sensor.
- Sync-Manager-Channel 3: Sync Manager 3 is used for process input data. It contains the Tx PDOs that are specified by the PDO assignment object 0x1C13 (hex.).

### A 6.1.5 EtherCAT State Machine

The EtherCAT® state machine is implemented in each EtherCAT®. Directly after switching on the capaNCNT 6500, the state machine is in the “Initialization” state. In this state, the master has access to the DLL information register of the slave hardware. The mailbox is not yet initialized, i.e. communication with the application (sensor software) is not yet possible. During the transition to the pre-operational state, the Sync Manager channels are configured for the mailbox communication. In the „Pre-Operational“ state, communication via the mailbox is possible, and it can access the object directory and its objects. In this state, no process data communication occurs. During the transition to the „Safe-Operational“ state, the process-data mapping, the Sync Manager channel of the process inputs and the corresponding FMMU are configured by the master. Mailbox communication continues to be possible in the „Safe-Operational“ state. The process data communication runs for the inputs. The outputs are in the „safe“ state. In the „Operational“ state, process data communication runs for the inputs as well as the outputs.

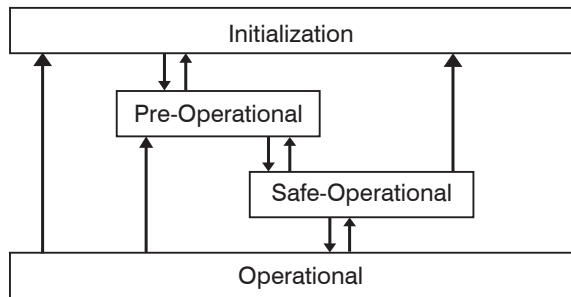

Fig. 44 EtherCAT State Machine

### A 6.1.6 CANopen over EtherCAT

The application level communication protocol in EtherCAT is based on the communication profile CANopen DS 301 and is designated either as “CANopen over EtherCAT” or CoE. The protocol specifies the object directory in the sensor, as well as the communication objects for the exchange of process data and acyclic messages. The sensor uses the following message types:

- Process Data Object (PDO). The PDO is used for the cyclic I/O communication, therefore for process data.
- Service Data Object (SDO). The SDO is used for acyclic data transmission.

The object directory is described in the chapter CoE Object Directory.

### A 6.1.7 Process Data PDO Mapping

Process Data Objects (PDOs) are used for the exchange of time-critical process data between master and slaves. Tx PDOs are used for the transmission of data from the slaves to the master (inputs), Rx PDOs are used to transmit data from the master to the slaves (outputs); not used in the capaNCNT 62x8. The PDO mapping defines which application objects (measurement data) are transmitted into a PDO. The capaNCNT 62x8 has a Tx PDO for the measuring data. The following measurements are available as process data:

- Counter            Measurement counter (32 Bit)
- Channel 1        Displacement Channel 1
- Channel 2        Displacement Channel 2
- Channel 3        Displacement Channel 3
- Channel 4        Displacement Channel 4

### A 6.1.8 Service Data SDO Service

Service Data Objects (SDOs) are primarily used for the transmission of data that are not time critical, e.g. parameter values. EtherCAT specifies the SDO services as well as the SDO information services: SDO services make possible the read/write access to entries in the CoE object directory of the device. SDO information services make it possible to read the object directory itself and to access the properties of the objects. All parameters of the measuring device can be read or changed in this way, or measurements can be transmitted. A desired parameter is addressed via index and subindex within the object directory.

### A 6.2 CoE – Object Directory

The CoE object directory (CANopen over EtherCAT) contains all the configuration data of the sensor. The objects in CoE object directory can be accessed using the SDO services. Each object is addressed using a 16-bit index.

#### A 6.2.1 Communication Specific Standard Objects (CiA DS-301)

Overview		
Index (h)	Name	Description
1000	Device type	Device type
1001	Error register	Error register
1008	Device name	Manufacturer device name
1009	Hardware version	Hardware version
100A	Software version	Software version
1018	Identity	Device identification
1A00	TxPDO Mapping	TxPDO Mapping
1C00	Sync. manager type	Sync. manager type
1C13	TxPDO assign	TxPDO assign

**Object 1000h: Device type**

1000	VAR	Device type	0x00200000	Unsigned32	ro
------	-----	-------------	------------	------------	----

Provides information about the used device profile and the device type.

**Object 1001h: Error register**

1001	VAR	Error register	0x00	Unsigned8	ro
------	-----	----------------	------	-----------	----

**Object 1008h: Manufacturer device name**

1008	VAR	Device name	DT6230	Visible String	ro
------	-----	-------------	--------	----------------	----

**Object 1009h: Hardware version**

1009	VAR	Hardware version	V x.xxx	Visible String	ro
------	-----	------------------	---------	----------------	----

**Object 100Ah: Software version**

100A	VAR	Software version	V x.xxx	Visible String	ro
------	-----	------------------	---------	----------------	----

**Object 1018h: Device identification**

1018	RECORD	Identity			
------	--------	----------	--	--	--

Subindices

0	VAR	Number of entries	4	Unsigned8	ro
1	VAR	Vendor ID	0x0000065E	Unsigned32	ro
2	VAR	Product code	0x003EDE73	Unsigned32	ro
3	VAR	Revision	0x00010000	Unsigned32	ro
4	VAR	Serial number	0x009A4435	Unsigned32	ro

The article number is deposit in the product code, the serial number of the sensor in serial number.

**Object 1A00h: TxPDO Mapping**

1A00	RECORD	TxPDO Mapping			
Subindices					
0	VAR	Number of entries	6	Unsigned8	ro
1	VAR	Subindex 001	0x0000:00	Unsigned32	ro
2	VAR	Subindex 002	0x6020:03	Unsigned32	ro
3	VAR	Subindex 003	0x6020:08	Unsigned32	ro
3	VAR	Subindex 004	0x6020:09	Unsigned32	ro
4	VAR	Subindex 005	0x6020:0A	Unsigned32	ro
6	VAR	Subindex 006	0x6020:0B	Unsigned32	ro

**Object 1C13h: TxPDO assign**

1C13	RECORD	TxPDO assign			
Subindices					
0	VAR	Number of entries	1	Unsigned8	ro
1	VAR	Subindex 001	0x1A00	Unsigned16	ro



## A 6.2.2 Manufacturer Specific Objects

### Overview

Index (h)	Name	Description
2010	Controller info	Controller information
2020	Channel 1 Info	Information and settings of channel 1
2021	Channel 2 Info	Information and settings of channel 2
2022	Channel 3 Info	Information and settings of channel 3
2023	Channel 4 Info	Information and settings of channel 4
2060	Controller Settings	Controller settings
2100	Controller Interface	Ethernet/EtherCAT settings
2200	Commands	Commands
6020	Measuring values	Measuring values

### Object 2010h: Controller information

2010	RECORD	Controller info			ro
------	--------	-----------------	--	--	----

### Subindices

Index	VAR	Name	Value	Access	Permissions
0	VAR	Number of entries	5	Unsigned8	ro
1	VAR	Name	DT6230	Visible String	ro
2	VAR	Serial No	xxxxxxx	Unsigned32	ro
3	VAR	Article No	xxxxxxx	Unsigned32	ro
4	VAR	Option No	xxx	Unsigned32	ro
5	VAR	Firmware version	xxx	Visible String	ro

**Object 2020h: Channel information**

2020	RECORD	Channel 1 info			ro
------	--------	----------------	--	--	----

## Subindices

0	VAR	Number of entries	16	Unsigned8	ro
1	VAR	Name	DL6230	Visible String	ro
2	VAR	Serial No	xxxxxxx	Unsigned32	ro
5	VAR	Status	Active	Enum	ro
7	VAR	Range	100	Unsigned32	rw
8	VAR	Unit	$\mu\text{m}$	Enum	ro
16	VAR	Linearization	Off	Enum	ro

The structure of objects 2021h to 2027h corresponds to the object 2020h.

**Object 2060h: Controller settings**

2060	RECORD	Controller Settings			ro
------	--------	---------------------	--	--	----

## Subindices

0	VAR	Number of entries	5	Unsigned8	ro
1	VAR	Sample rate	2083.3 Hz	Enum	rw
2	VAR	Averaging type	Off	Enum	rw
3	VAR	Averaging number	2	Enum	rw
4	VAR	Trigger	Off	Enum	rw
5	VAR	Analog Lowpass	Inactive	Enum	rw

**Object 2100h: Controller interface**

2100	RECORD	Controller Interface			ro
------	--------	----------------------	--	--	----

## Subindices

0	VAR	Number of entries	7	Unsigned8	ro
1	VAR	Ethernet/EtherCAT	EtherCAT	Enum	rw
3	VAR	Ethernet Adress type	Static	Enum	rw
4	VAR	Ethernet IPAddress	169.254.168.150	Visible String	rw
5	VAR	Ethernet Subnet	255.255.0.0	Visible String	rw
6	VAR	Ethernet Gateway	169.254.168.1	Visible String	rw
7	VAR	Ethernet Dataport	10001	Unsigned16	rw

**Object 2200h: Commands**

2200	RECORD	Commands			ro
------	--------	----------	--	--	----

## Subindices

0	VAR	Number of entries	2	Unsigned8	ro
1	VAR	Command	AVT1	Visible String	rw
2	VAR	Command Response	AVT1OK	Visible String	ro

Any commands can be sent to the controller with the object 2200h, for example, the math functions as these are not defined in the COE objects.

**Object 6020h: Measuring values**

6020	RECORD	Measuring values			ro
------	--------	------------------	--	--	----

## Subindices

0	VAR	Number of entries	11	Unsigned8	ro
3	VAR	Counter	xxxx	Unsigned32	ro
8	VAR	Channel 1	xxxx	Float	ro
9	VAR	Channel 2	xxxx	Float	ro
10	VAR	Channel 3	xxxx	Float	ro
11	VAR	Channel 4	xxxx	Float	ro

**A 6.3 Measurement Data Format**

The measuring values are transmitted as Float.

The unit can be read from the channel info objects 2020h to 2023h (unit).

#### A 6.4 EtherCAT Configuration with the Beckhoff TwinCAT®-Manager

For example the Beckhoff TwinCAT Manager can be used as EtherCAT Master.

- ➔ Copy the device description file (EtherCAT®-Slave Information) `Micro-Epsilon.xml` in the directory `\\TwinCAT\IO\EtherCAT` (for TwinCATV2.xx) or `\\TwinCAT\3.1\Config\IO\EtherCAT` (for TwinCAT V3.xx), before the measuring device can be configured via EtherCAT®.

The file is available online at:

[https://www.micro-epsilon.com/download/software/Micro-Epsilon\\_EtherCAT\\_ESI-File.zip](https://www.micro-epsilon.com/download/software/Micro-Epsilon_EtherCAT_ESI-File.zip)

EtherCAT®-Slave information files are XML files, which specify the characteristics of the Slave device for the EtherCAT® Master and contain information to the supported communication objects.

- ➔ Restart the TwinCAT Manager after copying.

#### Searching for a device:

- ➔ Select the tab `I/O Devices`, then `Scan`.

- ➔ Confirm with `Yes`.

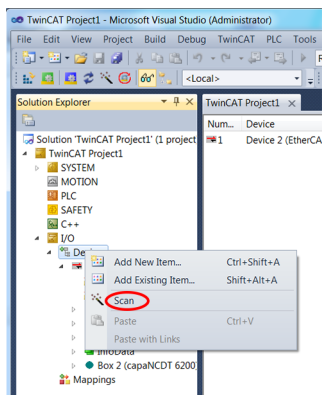

- ➔ Select a network card, where EtherCAT®-Slaves should be searching for.

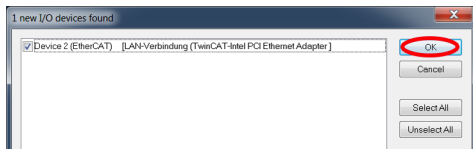

➡ Confirm with OK.

The window Scan for boxes (EtherCAT®-Slaves) appears.

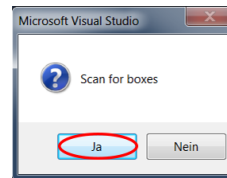

➡ Confirm with Ja.

The capaNCDT 62x8 is now listed in the Solution explorer.

➡ Now confirm the window Activate Free Run with Ja.

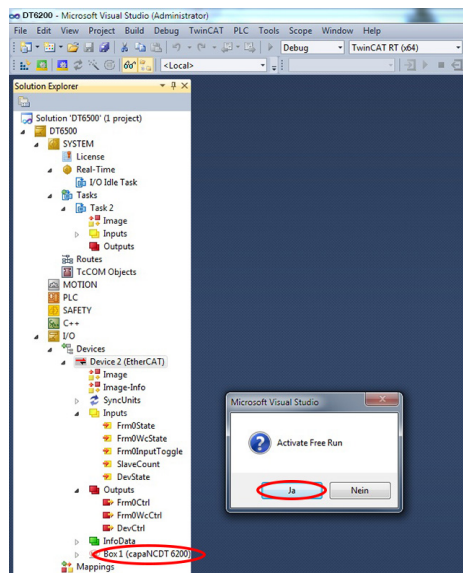

The current status should be at least PREOP, SAFEOP or OP on the Online side.

The screenshot shows the TwinCAT Project1 interface in Microsoft Visual Studio. The 'EtherCAT DC' tab is active, and the 'Online' sub-tab is selected. The 'State Machine' section shows the 'Current State' as 'OP' (Operational) and the 'Requested State' as 'OP'. The 'DLL Status' section shows ports A, B, C, and D all as 'No Carrier / Closed'. The 'File Access over EtherCAT' section has 'Download' and 'Upload' buttons. Below this is a table of variables:

Name	Online	Type	Size	>Ad...	In/O...	User...	Linked to
Counter	38738611	UDINT	4.0	41.0	Input	0	
Channel 1	49.713444	REAL	4.0	45.0	Input	0	
Channel 2	0.000000	REAL	4.0	49.0	Input	0	
Channel 3	0.000000	REAL	4.0	53.0	Input	0	
Channel 4	0.000000	REAL	4.0	57.0	Input	0	

Example for a complete object directory (subject to change without prior notice).

The screenshot shows the TwinCAT Project1 interface in Microsoft Visual Studio. The 'EtherCAT DC' tab is active, and the 'Online' sub-tab is selected. The 'Advanced' section is expanded, showing a list of objects with their indices, names, flags, and values.

Index	Name	Flags	Value
1000	Device type	RO	0x00020000 (131072)
1001	Error Register	RO	0x00 (0)
1008	Device name	RO	DT6200
1009	Hardware version	RO	1.0
100A	Software version	RO	1.1i
10180	Identify	RO	> 4 <
1A00.0	TxPDO Mapping	RO	> 8 <
1C00.0	Sync manager type	RO	> 4 <
1C130	TxPDO assign	RO	> 1 <
1C330	SM input parameter	RO	> 32 <
20100	Controller Info	RO	> 5 <
20200	Channel 1 Info	RO	> 16 <
20210	Channel 2 Info	RO	> 16 <
20220	Channel 3 Info	RO	> 16 <
20230	Channel 4 Info	RO	> 16 <

On the **Process** data side the PDO allocations can be read from the device.

The screenshot shows the TwinCAT Administrator interface. The 'Process Data' tab is selected in the top navigation bar. The 'PDO Content (0x1A00)' table is visible, with the following data:

Index	Size	Offs	Name	Type	Default (h...)
0x0200	4.0	2.0	Counter	UDINT	
0x0204	4.0	4.0	Channel 1	REAL	
0x0208	4.0	10.0	Channel 2	REAL	

The 'Load PDO info from device' button is located below the PDO Content table. The 'Sync Manager' table shows the following data:

SM	Size	Type	Fla...
0	128	Mbx...	
1	128	MbxIn	
2	0	Obj...	
3	0	Inputs	F

The selected measuring values are transmitted as process data in the status **SAFEOP** and **OP**.

Name	Online	Type	Size	>Ad...	In/O...	User...	Linked to
Counter	25512719	UDINT	4.0	41.0	Input	0	
Channel 1	49.716839	REAL	4.0	45.0	Input	0	
Channel 2	0.000000	REAL	4.0	49.0	Input	0	
Channel 3	0.000000	REAL	4.0	53.0	Input	0	
Channel 4	0.000000	REAL	4.0	57.0	Input	0	







MICRO-EPSILON MESSTECHNIK GmbH & Co. KG  
Koenigbacher Str. 15 · 94496 Ortenburg / Germany  
Tel. +49 (0) 8542 / 168-0 · Fax +49 (0) 8542 / 168-90  
info@micro-epsilon.com · www.micro-epsilon.com  
Your local contact: [www.micro-epsilon.com/contact/worldwide/](http://www.micro-epsilon.com/contact/worldwide/)

X9751459-A012093DTa  
© MICRO-EPSILON MESSTECHNIK