



More Precision

thermoMETER // Non-contact infrared temperature sensors



Non-contact temperature measurement - precise and reliable.

Temperature measurement with Micro-Epsilon

Infrared pyrometers from Micro-Epsilon are designed for measuring surface temperatures from $-50\text{ }^{\circ}\text{C}$ to $1600\text{ }^{\circ}\text{C}$. The infrared radiation emitted by a body is used for the measurement. As this measurement is a non-contact technology, the devices perform wear-free and can therefore be reliably used in the long term. Selectable models and optical systems enable to install the cameras in different distances from the surface. This enables measurements to the target from a safe distance in critical operation areas.

Large range of applications

Infrared pyrometers are used in a variety of applications for non-contact temperature measurement within any industry from factory automation, R&D to maintenance and process monitoring.

Proven technology

Infrared sensors developed and produced by Micro-Epsilon stand out due to their long service life, their robust construction and precise measurement results. These sensors are based on proven technologies which have been developed further by Micro-Epsilon. This is why these sensors also provide highly precise and reliable measurements in harsh environmental conditions.

Compact sensor design

For applications in restricted spaces, the sensors of the CT series are perfectly suitable. Even the standard models are considered one of the smallest sensors. For extremely tiny installation environments, miniaturized IR sensors are used.



Software included

Sensors with digital interface include the specially programmed CompactConnect software for free.

- Graphic display and recording of temperature readings for subsequent analysis and documentation
- Complete set up of parameters and remote control of the sensor
- Sophisticated signal processing features
- Output scaling and parameter set up of functional inputs

System requirements

- Windows XP / Vista / Windows 10
- USB 2.0 interface
- Hard drive with at least 30 MB of free disk space
- At least 128 MB of RAM
- CD-ROM drive

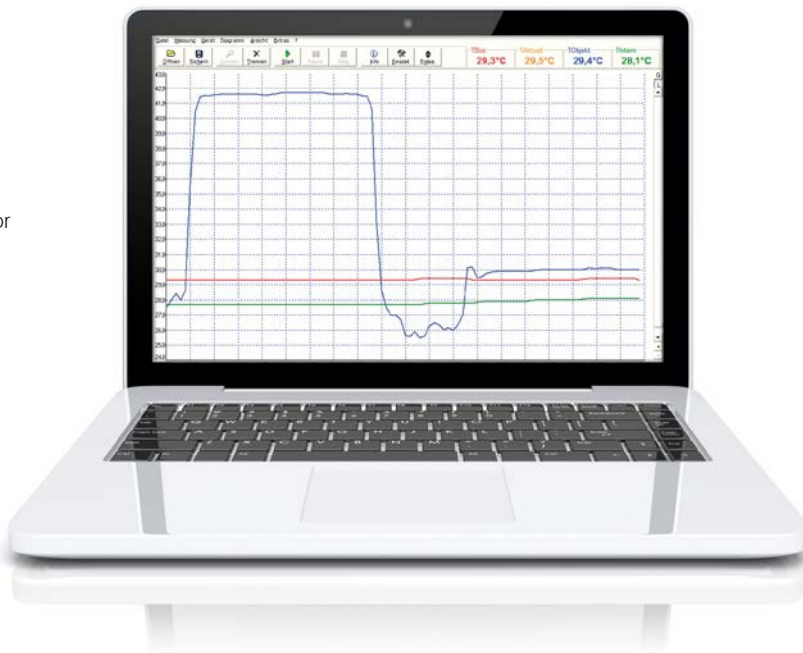

Non-contact measurement of the surface temperature

Each Micro-Epsilon IR sensor model incorporates different technologies that have a common denominator: non-contact temperature measurement. Due to this non-contact technology, measurement objects can be detected precisely and wear-free without physical influences.

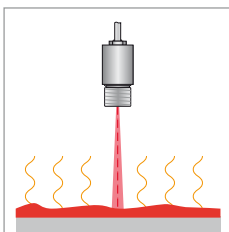

Large temperature measuring range

IR sensors from Micro-Epsilon are suitable for use across a wide measuring range. From low temperatures prevalent in cooling chains or laboratories, to the highest temperatures in hot melting materials or blast furnaces - the portable thermoMETER handheld products measure these temperatures precisely.

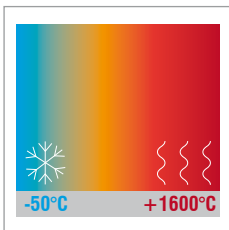

High speed measurements

For moving objects e.g. in transportation lines, thermoMETER sensors with extremely fast response times are available. These response times can only be achieved using high quality components.

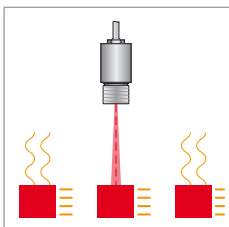

Precise and stable measurements

The thermoMETER product group is renowned for its high accuracy and high resolution. Particularly in temperature-critical applications, IR sensors from Micro-Epsilon are the preferred choice for easy, precise measurements.

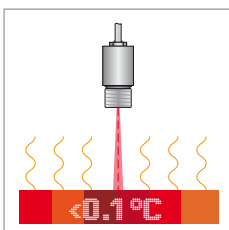

thermoMETER lenses

The measurement spot size with the desired working distance is a critical factor. In order to enable the ideal choice for any application, a large number of different lenses is available. These differ with respect to the relation between the target distance and the spot diameter.

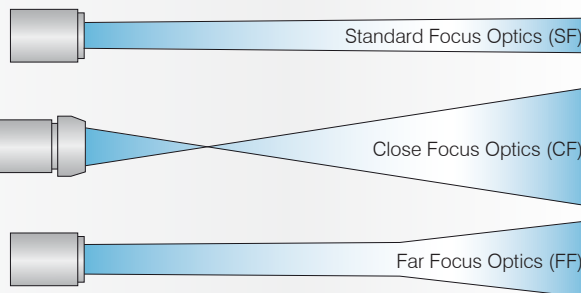

SF lenses (Standard Focus) have an almost linear relation while the CF lenses (Close Focus) have a smaller measurement spot in sensor-close distances. FF lenses (Far Focus) are especially suitable for large distances from the measurement object with a comparatively small measurement spot.

Detection of smallest measurement objects

Often, conventional IR sensors can not detect tiny, temperature-critical parts e.g. on chips and circuit boards. Due to the comprehensive range of optical systems, even smallest measurement objects $\lt; 1\text{mm}$ can be detected precisely.

Freely selectable distance from the measurement object

Depending on the application environment and the available installation space, the measurement distance of thermoMETER is freely selectable. Due to the large number of different lens types, small measurement diameters can also be detected with large distances.



High-Performance infrared pyrometer with double laser sighting

Page	Model	Temperature range
6 - 7	CTLaser	-100°C to 900°C

Infrared pyrometer for general purpose applications



Page	Model	Temperature range
10 - 11	CT	-100°C to 900°C
12 - 13	CTfast	-100°C to 900°C
14 - 15	CThot	-100°C to 900°C
16 - 17	CTM2	200°C to 1500°C
18 - 19	CTM3	0°C to 900°C

Compact infrared pyrometer for OEM applications



Page	Model	Temperature range
24 - 25	CSLaser	-100°C to 900°C
26 - 27	CS	-100°C to 350°C
28 - 29	CSmicro	-100°C to 1000°C
30 - 31	CSmicro 2W	-100°C to 900°C

High-Performance infrared pyrometer with double laser sighting

Spectral range	Ambient temperature	Description	Model	Page
8 to 14 μm	-20 °C to +85 °C	Universal Infrared pyrometer with laser spot marking	CTLaser	6 - 7

Infrared pyrometer for general purpose applications

Spectral range	Ambient temperature	Description	Model	Page
8 to 14 μm	-20 °C to +180 °C	Universal IR pyrometer for common applications	CT	10 - 11
8 to 14 μm	-20 °C to +120 °C	Infrared pyrometer for high speed measurements	CTfast	12 - 13
8 to 14 μm	-20 °C to +250 °C	Infrared pyrometer for extremely hot ambient temperature	CThot	14 - 15
1.6 μm	-20 °C to +125 °C	Infrared pyrometer for metal processing	CTM2	16 - 17
2.3 μm	-40 °C to +85 °C	Infrared pyrometer for metals & composite materials	CTM3	18 - 19

Compact infrared pyrometer for OEM applications

Spectral range	Ambient temperature	Description	Model	Page
8 to 14 μm	-20 °C to +85 °C	Two-wire infrared pyrometer with laser sighting & integrated controller	CSLaser	24 - 25
8 to 14 μm	-20 °C to +80 °C	OEM infrared pyrometer with integrated controller	CS	26 - 27
8 to 14 μm	-20 °C to +120 °C	Compact OEM infrared pyrometer with external controller	CSmicro	28 - 29
8 to 14 μm	-20 °C to +180 °C	Compact two-wire OEM infrared pyrometer with external controller	CSmicro 2W	30 - 31



thermoMETER CTLaser

Innovative infrared temperature sensor with laser sighting

- Measuring range from -50 °C to 975 °C
- Smallest spots from 0.9 mm - even with low object temperatures
- Double laser sighting for exact measuring field marking and focusing
- Optical system 75:1 with selectable focus settings
- Separate controller with programming keys and backlit display
- Up to 85 °C ambient temperature without cooling
- Automatic laser switch-off at 50 °C
- Selectable and scalable analog output, optional digital interfaces

Optical specifications thermoMETER CTLaser

□ = smallest spot size / focal point (mm)

Standard Focus

SF75 lens	75:1	20	19.5	19	18.5	18	17.5	17	16.5	16	20.5	25	34	43	52		
distance in mm		0	150	300	450	600	750	900	1050	1200	1350	1500	1800	2100	2400		

Close Focus

CF1 lens	75:1	20	9.1	6.4	0.9	9.9	24.8	39.7	54.6	69.6	84.5	99.4	114.4	129.3	159.1	189	218.9
CF2 lens	75:1	20	15.2	14	11.6	7.9	1.9	9.2	16.5	23.8	31.1	38.4	45.7	53	67.6	82.2	96.8
CF3 lens	75:1	20	16.6	15.7	14	11.4	7.1	2.75	8.4	14.1	19.8	25.5	31.2	36.9	48.3	59.6	71
CF4 lens	75:1	20	18.7	18.4	17.8	16.9	15.3	13.7	12.2	10.6	9	7.5	5.9	8.8	14.5	20.3	26
distance in mm		0	40	50	70	100	150	200	250	300	350	400	450	500	600	700	800

Model		CTL-SF75-C3
Optical resolution		75:1
Temperature range ¹⁾		-50 °C to 975 °C
Spectral range		8 to 14 μm
System accuracy ^{2), 3)}		±1 % or ±1 °C
Repeatability ²⁾		±0.5 % or ±0.5 °C
Temperature resolution		0.1 °C
Response time (90 % signal)		120 ms
Emissivity/gain ¹⁾		0.100 to 1.100
Transmissivity/gain ¹⁾		0.100 to 1.000
Signal processing ¹⁾		peak hold, valley hold, average; extended hold function with threshold and hysteresis
Certificate of calibration		optional
Outputs/analog	channel 1	0/4 to 20 mA, 0 to 5/10 V, thermocouple J, K
	channel 2	sensor temperature (-20 to 180 °C as 0 to 5 V or 0 to 10 V), alarm output
Outputs/analog	optional	relays: 2 x 60 VDC/42 VAC _{eff} ; 0.4 A; electrically isolated
Alarm output		open collector (24 V / 50 A)
Outputs/digital	optional	USB, RS232, RS485, Modbus RTU, Profibus DP, Ethernet
Output impedances	current output	mA max. 500 Ω (with 5 to 36 VDC)
	voltage output	min. 100 kΩ load impedance, thermocouple 20 Ω
Inputs		programmable functional inputs for external emissivity adjustment ambient temperature compensation, trigger (reset of hold functions)
Cable length		3 m (standard), 8 m, 15 m
Power supply		8 to 36 VDC; max. 160 mA
Laser		class II (635 nm), 1 mW, ON/OFF via controller or software
Protection class		IP65 (NEMA-4)
Ambient temperature		sensor: -20 °C to 85 °C (50 °C if Laser ON); controller: 0 °C to 85 °C
Storage temperature		sensor: -40 °C to 85 °C; controller: -40 °C to 85 °C
Relative humidity		10 to 95 %, non-condensing
Vibration	sensor	IEC 68-2-6: 3 G, 11 to 200 Hz, any axis
Shock	sensor	IEC 68-2-27: 50 G, 11 ms, any axis
Weight		sensor: 600 g; controller: 420 g

¹⁾ adjustable via programming keys or software

²⁾ ambient temperature: 23 ±5 °C; whichever is greater

³⁾ temperature of the object > 0 °C

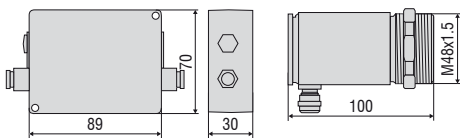

Product identification

CTL -	SF75-	C3
Cable length [3 m (standard) / 8 m / 15 m]		
Focus [SF75 / CF1 / CF2 / CF3 / CF4]		
thermoMETER CTLaser		

Accessories page 8 - 9

- Mounting bracket
- Air purge collar
- Rail mount adapter for controller
- Water cooled housing
- Interface kit
- CompactConnect software
- Certificate of calibration



CTLaser

Controller

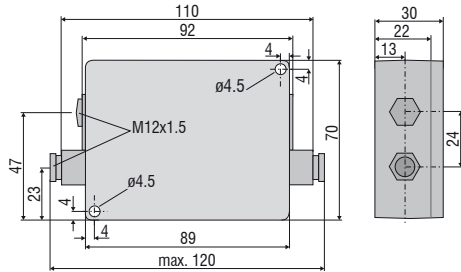

Sensor

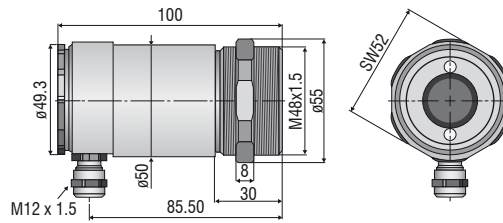

TM-FB-CTL Mounting bracket (fixed);
included in CTL scope of supply



TM-AB-CTL Mounting bracket (adjustable)



TM-W-CTL Water cooled housing and
air purge collar TM-AP-CTL,
mounted on adjustable mounting bracket TM-AB-CTL



TM-W-CTL Water cooled housing



TM-AP-CTL Air purge collar

Mechanical accessories		
Art. No.	Model	
2970238	TM-AB-CTL	Mounting bracket, adjustable, stainless steel
2970239	TM-AP-CTL	Air purge collar, stainless steel
2970241	TM-RAIL-CTL	Rail mount adapter for CTLaser controller
2970242	TM-COV-CTL	Closed cover for controller
2970243	TM-MN-CTL	Mounting nut, stainless steel (spare)
2970244	TM-FB-CTL	Mounting bracket, fixed, stainless steel (spare)
2970298	TM-A20UN-CTL	Screw adapter M48x1.5 on 20UN-2A screw including mounting nut
High temperature accessories		
2970240	TM-W-CTL	Water cooled housing, stainless steel, for ambient temperatures up to 175 °C
2970369	TM-MF-CTL	Mounting flange M48x1.5 for TM-PF-CTL
2970370	TM-AST300-CTL	Reflection protection tube M48x1.5, 300 mm length
2970371	TM-PA-CTL	Pipe adapter M48x1.5
2970372	TM-RM-CTL	Furnace wall mount accessory for CTL (TM-MF-CTL, TM-AST300-CTL and TM-PA-CTL)
2970412	TM-PF-CTL	Pipe flange M48x1.5 for directly mounting a CTL sensor
2970487	TM-CJA-CTL	Cooling Jacket Advanced - universal cooling jacket for CSLaser, CTLaser up to 315 °C (TM-CJA-FP-CTL front attachment is additionally required)
2970493	TM-CJA-FP-CTL	Front attachment for CTL, CSL
Calibration		
2970253	TM-CERT-CTL	Certificate of calibration
Interfaces		
2970728	TM-USBK-CTL	USB-interface board, cable with Micro-USB plug and adapter for USB-C- and USB-A, CompactConnect software (as download link), Quick reference, second cable gland for controller
2970246	TM-RS232K-CTL	RS232 interface, computer cable, CompactConnect software, second cable gland for controller
2970338	TM-RS485USBK-CTL	RS485-USB-adapter, incl. PC cable, CompactConnect software and CTmulti, second cable gland for use with interface board TM-RS485B-CTL
2970248	TM-RS485B-CTL	RS485-interface board incl. second cable gland
2970250	TM-PFBDPK-CTL	Profibus-DPV1 interface with plug-in connection
2970251	TM-ETHNK-CTL	Ethernet-Kit: interface board, external Ethernet adapter, CompactConnect software, second cable gland
2970252	TM-RI-CTL	Relay interface: two electrically isolated relays, 60 VDC/ 42 VAC _{eff} , 0.4 A
2970711	TM-MBRTU-CTL	Modbus-RTU-interface board incl. second cable gland



TM-CJA-CTL Cooling Jacket Advanced - cooling jacket suitable for ambient temperatures up to 315 °C (mounting bracket is included in the scope of delivery)



TM-PF-CTL and TM-MF-CTL mounting flange M48x1.5 for directly mounting a CTL sensor

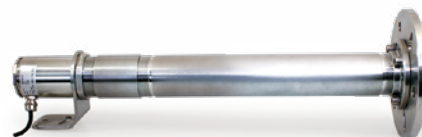

TM-RM-CTL Furnace wall mount accessory for CTLaser: TM-MF-CTL, TM-PF-CTL, TM-AST300-CTL and TM-PA-CTL



thermoMETER CT

Non-contact IR temperature sensor for common applications

- Measuring range from -50 °C to 975 °C
- One of the smallest 22:1 infrared sensors worldwide
- Up to 180 °C ambient temperature without cooling
- Separate controller with programming keys and backlit display
- Selectable and scalable analog output, optional digital interfaces
- Exchangeable sensors
- Best price sensor

Optical specifications thermoMETER CT

□ = smallest spot size / focal point (mm)

Standard Focus

SF02	2:1	5	53.8	102.5	151.3	200	251.3	302.5	353.8	405						
	distance in mm	0	100	200	300	400	500	600	700	800						
SF15	15:1	6.5	10.3	14.1	17.9	21.7	25.4	30.9	37.1	43.3	49.5	55.8	62	68.2	74.4	80.7
	distance in mm	0	75	150	225	300	375	450	525	600	675	750	825	900	975	1050
SF22	22:1	6.5	10.9	15.2	19.5	23.9	28.3	32.6	37	41.3	45.7	50				
	distance in mm	0	110	220	330	440	550	660	770	880	990	1100				

Close Focus (with optionally available CF lens)

CF02	2:1	5	3.9	2.8	2.5	4.8	6.4	8	11.3	14.6						
	distance in mm	0	10	20	23	30	35	40	50	60						
CF15	15:1	6.5	3.7	0.8	4.4	8.1	11.8	15.4	19.1	22.7						
CF22	22:1	7	3.8	0.6	4.4	8.2	12	15.8	19.6	23.4						
	distance in mm	0	5	10	15	20	25	30	35	40						

Model	CT-SF02-C3	CT-SF15-C3	CT-SF22-C3
Optical resolution	2:1	15:1	22:1
Temperature range ¹⁾	-50 °C to 600 °C	-50 °C to 600 °C	-50 °C to 975 °C
Spectral range	8 to 14 μm		
System accuracy ²⁾	±1 % or ±1 °C		
Repeatability ²⁾	±0.5 % or ±0.5 °C		
Temperature resolution	0.1 °C		
Response time	150 ms (95 %)		
Emissivity/gain ¹⁾	0.100 to 1.100		
Transmissivity/gain ¹⁾	0.100 to 1.100		
Signal processing ¹⁾	peak hold, valley hold, average; extended hold function with threshold and hysteresis		
Certificate of calibration	optional		
Outputs/analog	channel 1	0/4 to 20 mA, 0 to 5/10 V, thermocouple J, K	
	channel 2	sensor temperature (-20 to 180 °C as 0 to 5 V or 0 to 10 V), alarm output	
Outputs/analog	optional	relays: 2 x 60 VDC/42 VAC; 0.4 A; electrically isolated	
Outputs/digital	optional	USB, RS232, RS485, Modbus RTU, Profibus DP, Ethernet	
Output impedances	current output	mA max. 500 Ω (with 8 to 36 VDC)	
	voltage output	min. 100 kΩ load impedance, thermocouple 20 Ω	
Inputs	programmable functional inputs for external emissivity adjustment ambient temperature compensation, trigger (reset of hold functions)		
Cable length	1 m, 3 m (standard), 8 m, 15 m		
Power supply	8 to 36 VDC; max. 100 mA		
Protection class	IP65 (NEMA-4)		
Ambient temperature	sensor	-20 °C to 130 °C	-20 °C to 180 °C
	controller	0 °C to 85 °C	
Storage temperature	sensor	-40 °C to 130 °C	-40 °C to 180 °C
	controller	-40 °C to 85 °C	
Relative humidity	10 to 95 %, non-condensing		
Vibration	sensor	IEC 68-2-6: 3 G, 11 to 200 Hz, any axis	
Shock	sensor	IEC 68-2-27: 50 G, 11 ms, any axis	
Weight	sensor: 40 g; controller: 420 g		

¹⁾ adjustable via programming keys or software

²⁾ ambient temperature 23 ±5 °C; whichever is greater

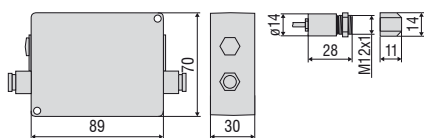

Product identification

CT-	SF02-	C3
Cable length [1 m / 3 m (standard) / 8 m / 15 m]		
Focus [SF02 / SF15 / SF22]		
thermoMETER CT		

Accessories page 20 - 23

- Ancillary CF lens
- Protective window
- Mounting bracket / mounting bolt
- Air purge collar
- Right angle mirror
- Rail mount adapter for controller
- Massive housing
- Protective tube
- Laser sighting aid
- Digital-interface kits
- Accessories kit for use in Ex areas
- Certificate of calibration



thermoMETER CTfast

IR temperature sensor with extremely short response time

- Measuring range from -50 °C to 975 °C
- One of the smallest infrared sensors worldwide with extremely short response times from 3 ms (50 % signal) to 6ms (90 % signal)
- Up to 120 °C ambient temperature without cooling
- Fast and scalable analog output with intelligent real-time data processing
- Separate controller with programming keys and backlit display

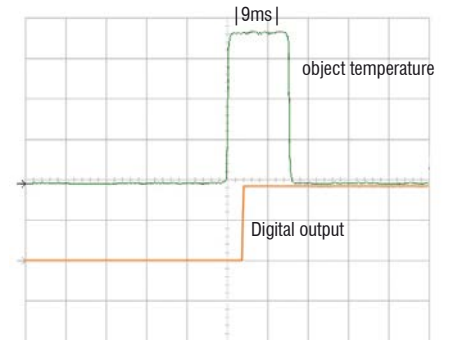

Switching output with a threshold of 50 % of the signal (SF15 model)

Optical specifications thermoMETER CTfast

□ =smallest spot size / focal point (mm)

Standard Focus														
SF15	15:1	6.5	11.6	16.6	21.7	26.7	35	43.3	51.6	59.9				
SF25	25:1	6.5	7.3	8	12	16	20	24	28	32	36	40	44	
	distance in mm	0	100	200	300	400	500	600	700	800	900	1000	1100	
Close Focus (with optionally available CF lens)														
CF15	15:1	7	3.9	0.8	4.7	8.6	12.5	16.4	20.3	24.2				
	distance in mm	0	5	10	15	20	25	30	35	40				
CF25	25:1	6.5	3.5	0.5	4	7.5	11	15.4	19.8	24.1	28.5			
	distance in mm	0	4	8	12	16	20	25	30	35	40			

Model	CTF-SF15-C3	CTF-SF25-C3
Optical resolution	15:1	25:1
Temperature range ¹⁾	-50 °C to 975 °C	
Spectral range	8 to 14 μm	
System accuracy ²⁾	±1 % or ±2 °C	
Repeatability ²⁾	±0.75 % or ±0.75 °C	
Temperature resolution ^{3), 4)}	0.2 °C	0.4 °C
Response time ⁵⁾	9 ms (90 %) at analog output 4 ms (50 %) at digital output	6 ms (90 %) at analog output; 3 ms (50 %) at digital output
Emissivity/gain ¹⁾	0.100 to 1.100	
Transmissivity/gain ¹⁾	0.100 to 1.100	
Signal processing ¹⁾	peak hold, valley hold, average; extended hold function with threshold and hysteresis	
Certificate of calibration	optional	
Outputs/analog	0/4 to 20 mA, 0 to 5/10 V, thermocouple J, K	
Alarm output	open collector (24 V / 50 A)	
Outputs/digital	standard: 0/10 V (10 mA); optional: relays 2 x 60 VDC/42 VAC; 0.4 A; electrically isolated	
Digital Interface	optional	USB, RS232, RS485, Modbus RTU, Profibus DP, Ethernet
Output impedances	current output	mA max. 500 Ω (with 8 to 36 VDC)
	voltage output	min. 100 kΩ load impedance, thermocouple 20 Ω
Inputs	programmable functional inputs for external emissivity adjustment ambient temperature compensation, trigger (reset of hold functions)	
Cable length	1 m, 3 m (standard), 8 m, 15 m	
Power supply	8 to 36 VDC; max. 100 mA	
Protection class	IP65 (NEMA-4)	
Ambient temperature	sensor: -20 °C to 120 °C; controller: 0 °C to 85 °C	
Storage temperature	sensor: -40 °C to 120 °C; controller: -40 °C to 85 °C	
Relative humidity	10 to 95 %, non-condensing	
Vibration	sensor	IEC 68-2-6: 3 G, 11-200 Hz, any axis
Shock	sensor	IEC 68-2-27: 50 G, 11 ms, any axis
Weight	sensor: 40 g; controller: 420 g	

¹⁾ adjustable via programming keys or software

²⁾ ambient temperature 23 ±5 °C; whichever is greater with dynamic noise compression

³⁾ temperature of the object ≥ 20 °C

⁴⁾ with dynamic adaption at low signal levels

⁵⁾ with time constant of 100 ms with adaptive averaging T_{avg} 25 °C

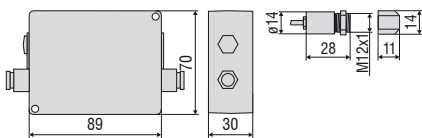

Product identification

CTF-	SF15-	C3
		Cable length [1 m / 3 m (standard) / 8 m / 15 m]
		Focus [SF15 / SF25]
thermoMETER CTFast		

Accessories page 20 - 23

- Ancillary CF lens
- Protective window
- Mounting bracket / mounting bolt
- Air purge collar
- Right angle mirror
- Rail mount adapter for controller
- Massive housing
- Protective tube
- Laser sighting aid
- Digital-interface kits
- Certificate of calibration



thermoMETER CHot

Housed IR temperature sensor for harsh ambient conditions

- Measuring range from -40 °C to 975 °C
- Up to 250 °C ambient temperature without cooling
- Pressure-resistant sensor head up to 10 bar (autoclave applications)
- Integrated high temperature cable
- For a number of applications in dryers, kilns, heat treatment in the processing of metals, plastics, textiles and in the semiconductor industry
- Narrow-focused lenses enable diagonal alignment to the target (avoids influence by material thickness)
- Selectable and scalable analog output, optional digital interfaces

Optical specifications thermoMETER CHot

□ = smallest spot size / focal point (mm)

Standard Focus										
SF10	10:1	6.5	14.9	23.3	31.6	40	51.6	63.3	74.9	86.5
	distance in mm	0	100	200	300	400	500	600	700	800

Model	CTH-SF10-C3H	
Optical resolution	10:1	
Temperature range ¹⁾	-40 °C to 975 °C	
Spectral range	8 to 14 μm	
System accuracy ²⁾	± 1 % or ± 1.5 °C	
Repeatability ²⁾	± 0.5 % or ± 0.5 °C	
Temperature resolution	0.25 °C	
Response time	100 ms	
Emissivity/gain ¹⁾	0.100 to 1.100	
Transmissivity/gain ¹⁾	0.100 to 1.100	
Signal processing ¹⁾	peak hold, valley hold, average; extended hold function with threshold and hysteresis	
Certificate of calibration	optional	
Outputs/analog	channel 1	0/4 to 20 mA, 0 to 5/10 V, thermocouple J, K
	channel 2	sensor temperature (-20 to 250 °C as 0 to 5 V or 0 to 10 V), alarm output
Outputs/analog	optional	relays: 2 x 60 VDC/42 VAC _{eff} ; 0.4 A; electrically isolated
Ausgänge/digital	optional	USB, RS232, RS485, Modbus RTU, Profibus DP, Ethernet
Output impedances	current output	mA max. 500 Ω (with 5 to 36 VDC)
	voltage output	min. 100 kΩ load impedance, thermocouple 20 Ω
Inputs	programmable functional inputs for external emissivity adjustment ambient temperature compensation, trigger (reset of hold functions)	
Cable length	3 m (standard), 8 m, 15 m	
Power supply	8 to 36 VDC; max. 100 mA	
Protection class	IP65 (NEMA-4)	
Ambient temperature	sensor: -20 °C to 250 °C; controller: 0 °C to 85 °C	
Storage temperature	sensor: -40 °C to 250 °C; controller: -40 °C to 85 °C	
Relative humidity	10 to 95 %, non-condensing	
Vibration	sensor	IEC 68-2-6: 3 G, 11 to 200 Hz, any axis
Shock	sensor	IEC 68-2-27: 50 G, 11 ms, any axis
Weight	sensor: 40 g (without massive housing), 200 g (with solid case); controller: 420 g	

¹⁾ adjustable via programming keys or software

²⁾ ambient temperature 23 ± 5 °C and object temperatures ≥ 20 °C; whichever is greater

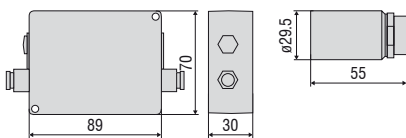

Product identification

CTH-	SF10-	C3H
		Length high temperature cable [3 m (standard) / 8 m / 15 m]
		Focus [SF10]
thermoMETER CThot		

Accessories page 20 - 23

- Rail mount adapter for controller
- Digital-interface kits
- Certificate of calibration



thermoMETER CTM2

Miniaturized temperature sensor with 1.6 μm measuring wavelength

- Measuring range from 250 °C to 1600 °C
- Up to 125 °C ambient temperature without cooling
- For metal processing such as welding, soldering, forming, sintering and for measurements of metal oxides and ceramics
- Extended compensation for measuring errors using short measuring wavelength (e.g. with emissivity changes or misadjustment)
- High compatibility with electromagnetic fields e.g. with induction welding
- Compact sensor for installation in confined spaces
- Selectable and scalable analog output, optional digital interfaces

Optical specifications thermoMETER CTM2

□ = smallest spot size / focal point (mm)

Standard Focus										
2SF40	40:1	6.5	10.7	14.9	19.1	23.3	27.4	31.6	35.8	40
2SF75	75:1	6.5	8.4	10.2	12.1	13.9	15.8	17.6	19.5	21.3
	distance in mm	0	200	400	600	800	1000	1200	1400	1600
Close Focus (integrated CF lens)										
2CF40	40:1	6.5	4.4	2.7	6	10.2	14.4	18.6	22.8	27
2CF75	75:1	6.5	3.8	1.5	4.4	8	11.7	15.3	19	22.6
	distance in mm	0	60	110	150	200	250	300	350	400

Model	CTM-2SF40-C3	CTM-2SF75-C3
Optical resolution	40:1	75:1
Temperature range ¹⁾	250 to 800 °C	385 to 1600 °C
Spectral range	1.6 μm	
System accuracy ^{2), 3)}	± (0.3 % of reading + 2 °C)	
Repeatability ²⁾	± (0.1 % of reading + 1 °C)	
Temperature resolution	0.1 °C	
Response time ⁴⁾	1 ms (90 %)	
Emissivity/gain ¹⁾	0.100 to 1.100	
Transmissivity/gain ¹⁾	0.100 to 1.100	
Signal processing ¹⁾	peak hold, valley hold, average; extended hold function with threshold and hysteresis	
Certificate of calibration	optional	
Outputs/analog	channel 1	0/4 to 20 mA, 0 to 5/10 V, thermocouple J, K
Outputs/analog	optional	relays: 2 x 60 VDC/42 VAC _{eff} ; 0.4 A; electrically isolated
Alarm output		open collector (24 V / 50 A)
Outputs/digital	optional	USB, RS232, RS485, Modbus RTU, Profibus DP, Ethernet
Output impedances	current output	mA max. 500 Ω (with 8 to 36 VDC)
	voltage output	min. 100 kΩ load impedance, thermocouple 20 Ω
Inputs		programmable functional inputs for external emissivity adjustment, ambient temperature compensation, trigger (reset of hold functions)
Cable length		3 m (standard), 8 m, 15 m
Power supply		8 to 36 VDC; max. 100 mA
Protection class		IP65 (NEMA-4)
Ambient temperature	sensor	-20 °C to 125 °C
	controller	0 °C to 85 °C
Storage temperature	sensor	-40 °C to 125 °C
	controller	-40 °C to 85 °C
Relative humidity		10 to 95 %, non-condensing
Vibration	sensor	IEC 68-2-6: 3 G, 11 to 200 Hz, any axis
Shock	sensor	IEC 68-2-27: 50 G, 11 ms, any axis
Weight		sensor: 40 g; controller: 420 g

¹⁾ adjustable via programming keys or software

²⁾ ambient temperature: 23 ± 5 °C

³⁾ ε = 1, response time 1 s

⁴⁾ with dynamic adaptation at low signal levels

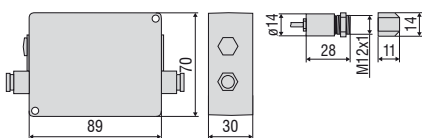

Product identification

CTM-	2	SF40-	C3
Cable length [3 m (standard) / 8 m / 15 m]			
Focus [SF40 / SF75 / CF40 / CF75]			
Spectral range [2=1.6 μm]			
thermoMETER CTM			

Accessories page 20 - 23

- Protective window
- Mounting bracket / mounting bolt
- Air purge collar
- Right angle mirror
- Rail mount adapter for controller
- Massive housing
- Protective tube
- Laser sighting aid
- Digital-interface kits
- Certificate of calibration



thermoMETER CTM3

Miniaturized temperature sensor with $2.3\ \mu\text{m}$ measuring wavelength for measurements from $50\ ^\circ\text{C}$

- Measuring range from $50\ ^\circ\text{C}$ to $1000\ ^\circ\text{C}$
- Up to $85\ ^\circ\text{C}$ ambient temperature without cooling
- For metal and composite processing
- Extended compensation for measuring errors using short measuring wavelength (e.g. with emissivity changes or misadjustment)
- High compatibility with electromagnetic fields e.g. with induction welding
- Compact sensor for installation in confined spaces
- Selectable and scalable analog output, optional digital interfaces

Optical specifications thermoMETER CTM3

□ = smallest spot size / focal point (mm)

Standard Focus											
3SF22	22:1	6.5	14.4	22.3	30.2	38.1	46	55.1	65.4	75.7	
3SF33	33:1	6.5	11.8	17	22.3	27.5	32.8	38	43.3	48.5	
3SF75H1	75:1	6.5	8.4	10.2	12.1	13.9	15.8	17.6	19.5	21.3	
distance in mm		0	200	400	600	800	1000	1200	1400	1600	
Close Focus (integrated CF lens)											
3CF22	22:1	6.5	6	5.4	5	9.2	14.4	19.6	24.9	30.1	35.3
3CF33	33:1	6.5	5.4	4.2	3.4	7	11.5	16	20.5	25	29.5
distance in mm		0	40	80	110	150	200	250	300	350	400
Close Focus (integrated CF lens)											
3CF75H1	75:1	6.5	3.8	1.5	4.4	8	11.7	15.3	19	22.6	
distance in mm		0	60	110	150	200	250	300	350	400	

Model	CTM-3SF22-C3	CTM-3SF33-C3	CTM-3SF75H1-C3
Optical resolution ¹⁾	22:1	33:1	75:1
Temperature range ^{2), 3)}	50 to 400 °C	100 to 600 °C	150 to 1000 °C
Spectral range	2.3 μm		
System accuracy ^{4), 5)}	±(0.3 % of reading + 2 °C)		
Repeatability ⁴⁾	±(0.1 % of reading + 1 °C)		
Temperature resolution (digital)	0.1 °C		
Response time ⁶⁾	1 ms (90 %)		
Emissivity/gain ²⁾	0.100 to 1.100		
Transmissivity ²⁾	0.100 to 1.100		
Signal processing ²⁾	peak hold, valley hold, average; extended hold function with threshold and hysteresis		
Certificate of calibration	optional		
Outputs/analog	channel 1	0/4 to 20 mA, 0 to 5/10 V, thermocouple J, K	
Outputs/analog	optional	relays: 2 x 60 VDC/42 VAC _{eff} ; 0.4 A; electrically isolated	
Alarm output		open collector (24 V / 50 A)	
Outputs/digital	optional	USB, RS232, RS485, Modbus RTU, Profibus DP, Ethernet	
Output impedances	current output	mA max. 500 Ω (with 8 to 36 VDC)	
	voltage output	min. 100 kΩ load impedance, thermocouple 20 Ω	
Inputs		programmable functional inputs for external emissivity adjustment, ambient temperature compensation, trigger (reset of hold functions)	
Cable length		3 m	
Power supply		8 to 36 VDC; max. 100 mA	
Protection class		IP65 (NEMA-4)	
Ambient temperature		sensor: -40 °C to 85 °C; controller: 0 °C to 85 °C	
Storage temperature		sensor: -40 °C to 125 °C; controller: -40 °C to 85 °C	
Relative humidity		10 to 95 %, non-condensing	
Vibration	sensor	IEC 68-2-6: 3 G, 11 to 200 Hz, any axis	
Shock	sensor	IEC 68-2-27: 50 G, 11 ms, any axis	
Weight		sensor: 40 g; controller: 420 g	

¹⁾ 90 % energy

²⁾ adjustable via programming keys or software

³⁾ target temperature > sensor temperature + 25 °C

⁴⁾ ambient temperature: 23 ± 5 °C

⁵⁾ ε=1, response time 1 s

⁶⁾ with dynamic adaption at low signal levels

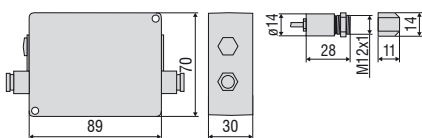

Product identification

CTM-	3	SF22-	C3
		Cable length [3 m]	
		Focus [SF22 / SF33 / SF75 / CF22 / CF33 / CF75]	
		Spectral range [2.3 μm]	
thermoMETER CTM			

Accessories page 20 - 23

- Protective window
- Mounting bracket / mounting bolt
- Air purge collar
- Right angle mirror
- Rail mount adapter for controller
- Massive housing
- Protective tube
- Laser sighting aid
- Digital-interface kits
- Certificate of calibration

CT / CTfast / CTM2/M3

controller

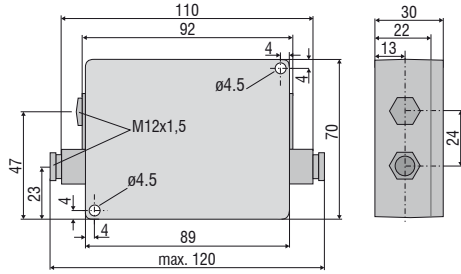

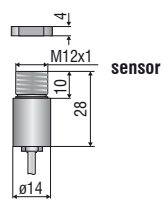
**ancillary CF lens
(optional)**

CThot

controller

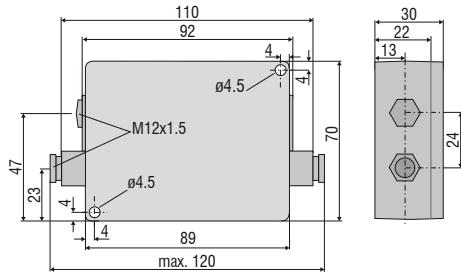

sensor with protective housing

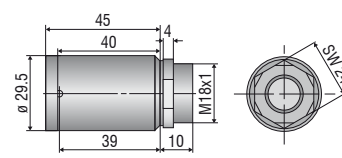

Mechanical accessories		
Art. No.	Model	
2970203	TM-FB-CT	Mounting bracket, fixed
2970325	TM-FB2-CT	Mounting bracket, adjustable in one axis, for simultaneous assembly of CT sensor and laser sighting aid
2970336	TM-FBMH-CT	Mounting bracket, adjustable in one axis, for massive housing
2970204	TM-AB-CT	Mounting bracket, adjustable in 2 axes
2970205	TM-MB-CT	Mounting bolts with M12x1 thread
2970206	TM-MG-CT	Mounting fork, adjustable in 2 axes, with M12x1 fastening
2970207	TM-AP-CT	Air purge collar for sensors from 10:1 lens
2970335	TM-APS-CT	Air purge collar for sensors from 10:1 lens made from stainless steel
2970208	TM-AP2-CT	Air purge collar for sensor with 2:1 lens
2970209	TM-APL-CT	Air purge collar, laminar
2970210	TM-APLCF-CT	Air purge collar, laminar with integrated ancillary CF lens
2970357	TM-APLCFH-CT	Air purge collar, laminar with integrated ancillary CF lens for M sensors
2970386	TM-APMH-CT	Air purge collar made from stainless steel for massive housing
2970463	TM-TAS-CT	Pivoted joint for CT sensors
2970211	TM-RAM-CT	Right angle mirror for measurements 90 °C to the sensor axis
2970212	TM-RAIL-CT	Rail mount adapter for CT controller
2970213	TM-COV-CT	Closed cover for controller
2970214	TM-MHS-CT	Massive housing made from stainless steel
2970215	TM-MHSCF-CT	Massive housing made from stainless steel with integrated ancillary CF lens
2970358	TM-MHSCFH-CT	Massive housing made from stainless steel with integrated ancillary CF lens for M sensors
2970216	TM-MHA-CT	Massive housing made from anodized aluminum
2970217	TM-MHACF-CT	Massive housing made from stainless steel with integrated ancillary CF lens
2970359	TM-MHACFH-CT	Massive housing made from anodized aluminum with integrated ancillary CF lens for M sensors
2970326	TM-PA-CT	Pipe adapter for the mounting of reflection protection tubes
2970327	TM-ST20-CT	Reflection protection tube, length 20 mm
2970328	TM-ST40-CT	Reflection protection tube, length 40 mm
2970329	TM-ST88-CT	Reflection protection tube, length 88 mm
2970221	TM-LST-CT	Laser sighting aid for CT sensors incl. batteries (2xAlkaline AA)
2970300	TM-LSTOEM-CT	OEM laser sighting aid, 635 nm, 3.5 m cable, for connection to CT controller
2970300.008	TM-LSTOEM-CT(008)	OEM laser sighting aid, 635 nm, 8 m cable, for connection to CT controller

Optical accessories		
Art. No.	Model	
2970201	TM-CF-CT	Ancillary CF lens (only for SF models)
2970202	TM-PW-CT	Protective window (only for SF models)
2970297	TM-CFAG-CT	Ancillary lens with external thread
2970330	TM-CFH-CT	Ancillary lens for M sensors
2970331	TM-CFHAG-CT	Ancillary lens with external thread for M sensors
2970299	TM-PWAG-CT	Protective window with external thread
2970332	TM-PWH-CT	Protective window for M sensors
2970333	TM-PWHAG-CT	Protective window with external thread for M sensors

Interfaces		
Art. No.	Model	
2970729	TM-USBK-CT	USB-Interface board, cable with Micro-USB plug and adapter for USB-C and USB-A, CompactConnect software (as download), Quick reference, second cable gland for controller
2970224	TM-RS232K-CT	RS232 interface: RS232 interface, computer cable, CompactConnect software, second cable gland for controller
2970338	TM-RS485USBK-CT	RS485-USB-adapter, incl. PC cable, CompactConnect software and CTmulti, second cable gland for use with interface board TM-RS485B-CT
2970226	TM-RS485B-CT	RS485-interface board incl. second cable gland
2970228	TM-PFBDPK-CT	Profibus-DPv1 interface for thermoMETER CT with plug-in connection
2970229	TM-ETHNK-CT	Ethernet-Kit: interface board, external Ethernet adapter, CompactConnect software, second cable gland
2970230	TM-RI-CT	Relay interface: two electrically isolated relays, 60 VDC/ 42 VAC _{eff} , 0.4 A
2970719	TM-MBRTU-CT	Modbus-RTU-interface board incl. second cable gland

Calibration		
Art. No.	Model	
2970231	TM-CERT-CT	Certificate of calibration
2970310	TM-HTCERT-CT	Certificate of calibration for CTM sensors



TM-FB-CT Mounting bracket, adjustable in one axis



TM-MB-CT mounting bolt with M12x1 thread adjustable in one axis



TM-AB-CT Mounting bracket, adjustable in two axes



TM-MB-CT mounting bolt with M12x1 thread adjustable in one axis



TM-APL-CT Air purge collar, laminar and TM-MG-CT Mounting fork



TM-MG-CT Mounting fork with M12x1 thread, adjustable in two axes



TM-APL-CT Air purge collar, laminar and TM-MG-CT Mounting fork



TM-RAIL-CT rail mount adapter for controller



TM-KF40GE-CT KF40 Flange with Ge window
TM-KF40B270-CT KF40 Flange for CTM-1,-2,-3 with B270 window



TM-APMH-CT Air purge collar made from stainless steel for massive housing



TM-PA-CT Pipe adapter for reflection protection tube



TM-ST40-CT Reflection protection tube

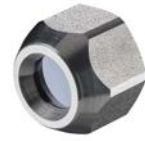

TM-CF-CT Ancillary CF lens (only for SF models)



TM-CFAG-CT Ancillary CF lens with external thread
TM-PWAG-CT Protective window with external thread



TM-LST-CT Laser sighting aid, battery-operated
(2x Alkaline AA), for alignment of CT sensors
(dimensions identical to CT sensor)



TM-FB2-CT
Mounting bracket for sensor and laser sighting aid



TM-RAM-CT
Right angle mirror



TM-MHS-CT Massive housing, stainless steel
TM-MHA-CT Massive housing, aluminum

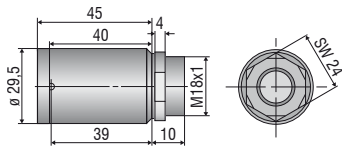

TM-TAS-CT Pivoted joint for CT sensors



Dirt and deposit on the lens like smoke, steam and high air humidity (condensation) are avoided or reduced by using an air purge collar.

TM-AP-CT
Standard air purge collar for 10:1 / 15:1 / 22:1 lenses
TM-APS-CT
Air purge collar, stainless steel



TM-AP2-CT
Standard air purge collar for 2:1 lens



thermoMETER CSLaser

Miniature IR sensor with integrated controller and laser sighting

- Measuring range from -30 to 1000 °C, measuring fields from 1.4 mm and response times from 150 ms
- Optical resolution up to 50:1 with selectable focus settings
- Double laser sighting with 2 rays for exact measuring field marking and focusing
- Scalable 4-20 mA two-wire analog output and simultaneous alarm output
- Optional USB interface and software for programming
- Emissivity directly adjustable via rotary controller or software
- Protection against short circuit and polarity change
- Up to 85 °C ambient temperature without cooling
- Automatic laser switch-off at 50 °C
- Extensive supply voltage range: 5 - 28 VDC

Optical specifications thermoMETER CSLaser CSL-SF50

□ = smallest spot size / focal point (mm)

Standard Focus																	
SF50 lens	50:1	20	20.5	21	21.5	22	22.5	23	23.5	24	29.5	35	46	57	68		
distance in mm	0	150	300	450	600	750	900	1050	1200	1350	1500	1800	2100	2400			
Close Focus																	
CF1 lens	50:1	20	9.4	6.7	1.4	10.6	25.9	41.1	56.4	71.7	87	102.3	117.6	132.9	163.4	194	224.6
CF2 lens	50:1	20	15.5	14.3	12.1	8.7	3	10.7	18.3	26	33.7	41.3	49	56.7	72	87.3	102.7
CF3 lens	50:1	20	16.8	16	14.4	12	8	4	10	16	22	28	34	40	52	64	76
CF4 lens	50:1	20	19	18.8	18.3	17.6	16.3	15.1	13.9	12.7	11.4	10.2	9	12.2	18.7	25.1	31.6
distance in mm	0	40	50	70	100	150	200	250	300	350	400	450	500	600	700	800	

Model	CSL-SF50
Optical resolution	50:1
Temperature range ¹⁾	-30 °C to 1000 °C
Spectral range	8 to 14 μm
System accuracy ³⁾	±1 % or ±1 °C
Repeatability ³⁾	±0.5 % or ±0.5 °C
Temperature resolution	0.1 °C
Response time (90 % signal)	150 ms
Emissivity/gain ¹⁾	0.100 to 1.100
IR window correction ²⁾	0.100 to 1.100
Signal processing ²⁾	peak hold, valley hold, average; extended hold function with threshold and hysteresis
Outputs/analog	4 to 20 mA
Output/alarms	0 to 30 V / 500 mA (open collector)
Outputs/digital (optional)	mono-/bidirectional, 9.6 kBaud, 0/3 V level, USB
Output/impedance	max. 1000 Ω (depends on supply voltage)
Power consumption (only laser)	45 mA at 5 V / 20 mA at 12 V / 12 mA at 24 V
Power supply	5 to 28 VDC
Laser	class II, (635 nm), 1 mW, ON/OFF via software
Protection class	IP65 (NEMA-4)
Ambient temperature	-20 °C to 85 °C (50 °C if Laser ON)
Storage temperature	-40 °C to 85 °C
Relative humidity	10 to 95 %, non-condensing
Vibration	IEC 68-2-6: 3 G, 11 to 200 Hz, any axis
Shock	IEC 68-2-27: 50 G, 11 ms, any axis
Weight	600 g

¹⁾ adjustable via sensor or software

²⁾ adjustable via software

³⁾ ambient temperature 23 ±5 °C; whichever is greater; ambient temperature ≥ 0 °C

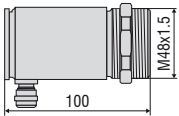

Product identification

CSL - SF50
 Focus [SF50 / CF1 / CF2 / CF3 / CF4]
 thermoMETER CSLaser

Accessories page 32 - 35

- Mounting bracket
- Air purge collar
- Rail mount adapter for controller
- Water cooled housing
- Certificate of calibration
- USB kit (TM-USBK-CS) p.55





thermoMETER CS

Compact OEM sensor with integrated controller

- Measuring range from -40 °C to 400 °C
- Applicable in ambient temperatures up to 80 °C without cooling
- Robust, silicon-coated lens
- Integrated controller with LED alarm display and intelligent sighting aid, alarm signal, temperature-code display or self-diagnostics
- Protection against short circuit and polarity change
- Programmable controller
- Different outputs: 0-10 V or 0-5 V freely scalable, alarm output, digital output
- Optional USB interface and software for programming, direct, serial 9.6 / 115.2 kBaud interface
- Extensive supply voltage range: 5 - 30 VDC
- Best price - ideal for OEM applications
- *Please note: available from 10 pieces*

Optical specifications thermoMETER CS

□ = smallest spot size / focal point (mm)

Standard Focus										
SF15	15:1	6.5	11.6	16.6	21.7	26.7	35	43.3	51.6	59.9
	distance in mm	0	100	200	300	400	500	600	700	800
Close Focus (with optionally available CF lens)										
CF15	15:1	7	3.9	0.8	4.7	8.6	12.5	16.4	20.3	24.2
	distance in mm	0	5	10	15	20	25	30	35	40

Model	CS-SF15-C1
Optical resolution	15:1
Temperature range ¹⁾	-40 °C to 400 °C
Spectral range	8 to 14 μm
System accuracy ²⁾	±1.5 % or ±1.5 °C
Repeatability ²⁾	±0.75 % or ±0.75 °C
Temperature coefficient ³⁾	±0.05 °C/K or ±0.05 %/K
Temperature resolution ⁴⁾	0.05 °C
Response time	14 ms to 999 s (90 %), adjustable
Emissivity/Gain	0.100 to 1.100 (adjustable via 0 to 10 VDC input or software)
Transmissivity/gain	0.100 to 1.100 (adjustable via software)
Signal processing ¹⁾	Peak hold, valley hold, average; extended hold function with threshold and hysteresis
Outputs/analog	0 to 5 V or 0 to 10 V, freely scalable via software
Alarm output	Alarm 0-30 V / 50 mA (open collector)
3-state alarm output	adjustable thresholds and voltage levels for: no alarm, pre-alarm, alarm
Outputs/digital	mono-/bidirectional, 9.6 / 115.2 kBaud (adjustable via software), 0/3 V level/USB optional
LED functions	alarm display, automatic aiming aid, self-diagnostics, temperature display (via temp. code)
Inputs	programmable functional inputs for external emissivity adjustment, ambient temperature compensation (0 to 10 VDC), hold function or RS232 / USB (optional) communication
Cable length	1 m (standard), 3 m, 8 m, 15 m
Power supply	4 mA (without LED); 10 mA (5 to 30 VDC)
Protection class	IP63 (NEMA-4)
Ambient temperature	-20 °C to 80 °C
Storage temperature	-40 °C to 85 °C
Relative humidity	10 to 95 %, non-condensing
Vibration	IEC 68-2-6: 3 G, 11 to 200 Hz, any axis
Shock	IEC 68-2-27: 50 G, 11 ms, any axis
Weight	approx. 58 g

¹⁾ Adjustable via software

²⁾ Ambient temperature: 23 ±5 °C; whichever is greater; object temperature ≥ 0 °C

³⁾ For ambient temperatures < 18 °C and > 28 °C, whichever is greater

⁴⁾ With object temperature < 100 °C and time constant of > 0.2 s

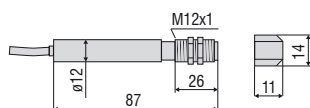

Product identification

CS -	SF15-	C1
		Cable length [1 m (standard) / 3 m / 8 m / 15 m]
		Focus [SF]
thermoMETER CS		

Accessories page 32 - 35

- Ancillary CF lens
- Protective window
- Mounting bracket / mounting bolt
- Air purge collar
- Right angle mirror



thermoMETER CSmicro

Miniature OEM infrared temperature sensor with controller integrated in the cable

- Measuring range from -40 °C to 1030 °C
- Applicable in ambient temperatures up to 120 °C without cooling (sensor)
- Robust, silicon-coated lens
- Integrated controller with LED alarm display and intelligent sighting aid, alarm signal, temperature-code display or self-diagnostics
- Integrated controller in the cable
- Scalable analog output and simultaneous alarm output
- Protection against short circuit and polarity change
- Programmable controller
- Optional USB interface and software for programming
- Best price - ideal for OEM applications

Optical specifications thermoMETER CSmicro

□ = smallest spot size / focal point (mm)

Standard Focus											
SF15	15:1	6.5	11.6	16.6	21.7	26.7	35	43.3	51.6	59.9	
	distance in mm	0	100	200	300	400	500	600	700	800	
Close Focus (with optionally available CF lens)											
CF15	15:1	7	3.9	0.8	4.7	8.6	10.9	12.5	16.4	20.3	24.2
	distance in mm	0	5	10	15	20	23	25	30	35	40

Model	CSmi-SF15-C1
Optical resolution	15:1
Temperature range	-40 °C to 1030 °C ¹⁾
Spectral range	8 to 14 μm
System accuracy	±1.0 % or ±1.0 °C ⁴⁾
Repeatability	±0.5 % or ±0.5 °C ³⁾
Temperature coefficient	± 0.05 °C/°C or ± 0.05 % °C ⁵⁾
Temperature resolution	0.15 °C ⁶⁾
Response time (90 %)	14 ms (adjustable up to 999 s via optional programming adapter)
Emissivity/Gain	0.100 to 1.100 ²⁾
Transmissivity/gain ¹⁾	0.100 to 1.100
Signal processing ¹⁾	peak hold, valley hold, average; extended hold function with threshold and hysteresis
Dimensions of controller	length 35 mm; ø12 mm
Outputs/analog	0 to 5 V or 0 to 10 V 1/10/100 mV/°C
Max. loop resistance	-
Outputs/alarm	alarm (50 mA / 24 V)
Outputs/digital (optional)	mono-/bidirectional, 9.6 kBaud, 0/3 V level, alternative USB
Inputs	programmable functional inputs for external emissivity adjustment (0 to 5 VDC), hold function or USB communication
LED functions	alarm display, automatic aiming aid, self-diagnostics, temperature display (via temp. code)
Cable length	1 m (standard length); 0.5 m between sensor and controller; 0.4 m between controller and terminal device
Power supply	9 mA (5 to 30 VDC)
Protection class	IP65 (NEMA-4) sensor head
Ambient temperature	sensor: -20 °C to 120 °C controller: -20 °C to 80 °C
Storage temperature	-40 °C to 85 °C (sensor and controller)
Relative humidity	10 to 95 %, non-condensing
Vibration	IEC 68-2-6: 3 G, 11 to 200 Hz, any axis
Shock	IEC 68-2-27: 50 G, 11 ms, any axis
Weight	42 g

¹⁾ adjustable via software

²⁾ adjustable via 0 to 5 VDC input or software

³⁾ ambient temperature 23 ± 5 °C; whichever is greater; object temperature ≥ 0 °C

⁴⁾ ambient temperature 23 ± 5 °C; whichever is greater; object temperature > 20 °C

⁵⁾ with object temperature < 100 °C; time constant from > 0.2 s

⁶⁾ with object temperature > 20 °C; time constant from > 0.2 s

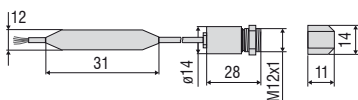

Product identification

CSmi -	SF15-	C1
Cable length [1 m (standard) other cable lengths on request]		
Focus [SF / CF]		
thermoMETER CSmicro		

Accessories page 32 - 35

- Ancillary CF lens
- Protective window
- Mounting bracket / mounting bolt
- Air purge collar
- Right angle mirror
- USB kit



thermoMETER CSmicro 2W

Miniature OEM two-wire IR temperature sensor with controller integrated in the cable

- Measuring range from -40 °C to 1030 °C
- Applicable in ambient temperatures up to 180 °C without cooling (sensor)
- Robust, silicon-coated lens
- Integrated controller with LED alarm display and intelligent sighting aid, alarm signal, temperature-code display or self-diagnostics
- Integrated controller in the cable
- Scalable analog output and simultaneous alarm output
- Protection against short circuit and polarity change
- Programmable controller
- Optional USB interface and software for programming
- Best price - ideal for OEM applications

Optical specifications thermoMETER CSmicro 2W

□ = smallest spot size / focal point (mm)

Standard Focus										
SF15	15:1	6.5	11.6	16.6	21.7	26.7	35	43.3	51.6	59.9
SF22	22:1	6.5	10.5	14.4	18.4	22.3	26.3	30.2	34.2	38.1
	distance in mm	0	100	200	300	400	500	600	700	800
Close Focus (with optionally available CF lens)										
CF15	15:1	7	3.9	0.8	4.7	8.6	12.5	16.4	20.3	24.2
CF22	22:1	7	3.8	0.6	4.4	8.2	12	15.8	19.6	23.4
	distance in mm	0	5	10	15	20	25	30	35	40

Model	CSmi2W-SF15-C1	CSmi2W-SF22H-C1
Optical resolution	15:1	22:1
Temperature range	-40 °C to 1030 °C ¹⁾	
Spectral range	8 to 14 μm	
System accuracy	±1.0 % or ±1.0 °C ³⁾	
Repeatability	±0.5 % or ±0.5 °C ³⁾	
Temperature coefficient	±0.05 °C/°C or ±0.05 % °C ⁴⁾	
Temperature resolution	0.1 °C ⁵⁾	
Response time (90 %)	30 ms	150 ms
Emissivity/Gain	0.100 to 1.100 ²⁾	
Transmissivity/gain ¹⁾	0.100 to 1.100	
Signal processing ¹⁾	peak hold, valley hold, average; extended hold function with threshold and hysteresis	
Dimensions of controller	length 35 mm; ø12 mm	
Outputs/analog	4 to 20 mA	
Max. loop resistance	1000 Ω ⁶⁾	
Outputs/alarm	0-30 V / 500 mA (open collector)	
Outputs/digital (optional)	mono-/bidirectional, 9.6 kBaud, 0/3 V level, alternative USB	
Inputs	programmable functional input for triggered signal output or peak hold function	
LED functions	alarm display, automatic aiming aid, self-diagnostics, temperature display (via temp. code)	
Cable length	1 m (standard length); 0.5 m between sensor and controller; 0.4 m between controller and terminal device	
Power supply	4...20 mA (5 to 30 VDC)	
Protection class	IP65 (NEMA-4) sensor head	
Ambient temperature	sensor: -20 °C to 120 °C controller: -20 °C to 75 °C	sensor: -20 °C to 180 °C controller: -20 °C to 75 °C
Storage temperature	-40 °C to 85 °C (sensor and controller)	
Relative humidity	10 to 95 %, non-condensing	
Vibration	IEC 68-2-6: 3 G, 11 to 200 Hz, any axis	
Shock	IEC 68-2-27: 50 G, 11 ms, any axis	
Weight	42 g	

¹⁾ adjustable via software

²⁾ adjustable via 0 to 5 VDC input or software

³⁾ ambient temperature 23 ±5 °C; whichever is greater; object temperature ≥ 0 °C

⁴⁾ with object temperature < 100 °C; time constant from > 0.2 s

⁵⁾ with object temperature > 20 °C; time constant from > 0.2 s

⁶⁾ depends on supply voltage

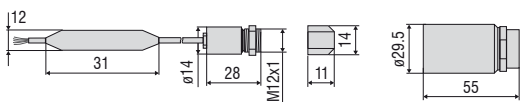

Product identification

CSmi2W -	SF15-	C1
Cable length [1m (standard) / 3m / 8m / 15m]		
Focus [SF / CF]		
thermoMETER CSmi2W (TwoWire)		

Accessories page 32 - 35

- Ancillary CF lens
- Protective window
- Mounting bracket / mounting bolt
- Air purge collar
- Right angle mirror
- USB kit

CSLaser

sensor

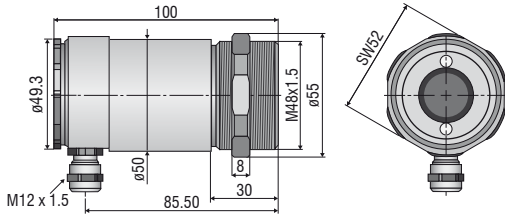

CS

sensor with integrated controller

ancillary CF lens (optional)

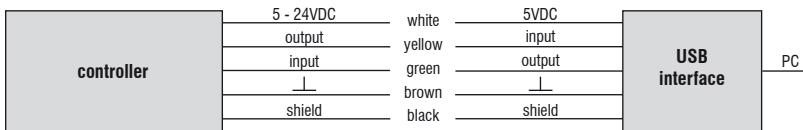
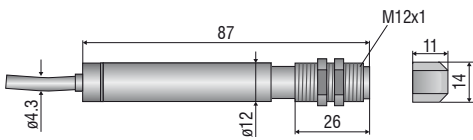

CSmicro / CSmicro 2W

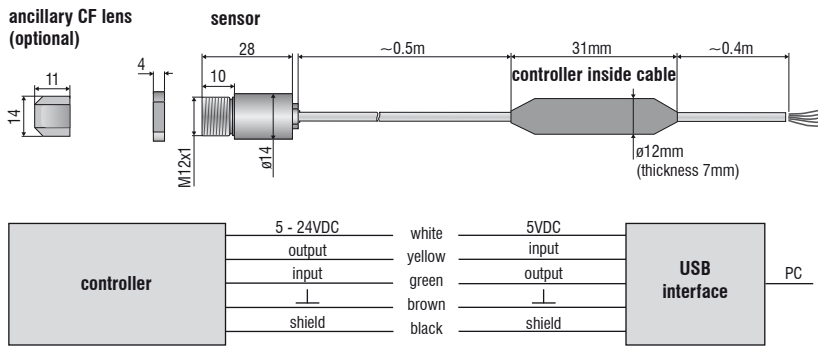

Mechanical accessories CS / CSmicro / CSmicro 2W

Art. No.	Model	
2970279	Emissivity	Mounting bracket, fixed
2970280	TM-AB-CS	Mounting bracket, adjustable
2970281	TM-MB-CS	Mounting bolts with M12x1 thread
2970282	TM-MG-CS	Mounting fork, adjustable in 2 axes, with M12x1 fastening
2970283	TM-AP-CS	Air purge collar for 10:1 sensors
2970284	TM-APL-CS	Air purge collar, laminar
2970285	TM-APLCF-CS	Air purge collar, laminar with integrated ancillary CF lens
2970286	TM-RAM-CS	Right angle mirror for measurements 90 °C to the sensor axis
2970718	TM-USBK-CS	USB kit: USB programming adapter, CompactConnect software (as download)

Optical accessories CS / CSmicro / CSmicro 2W

2970277	TM-CF-CS	Ancillary CF lens for CS models
2970278	Aluminum	Protective window for CS models

Calibration CS / CSmicro / CSmicro 2W

2970288	TM-CERT-CS	Certificate of calibration
---------	------------	----------------------------



TM-FB-CS mounting bracket, fixed



TM-MG-CS Mounting fork with M12x1 thread, adjustable in two axes

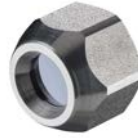

TM-CF-CS Ancillary CF lens (only for LT models)



TM-AP-CS Air purge collar for 10:1 sensors



TM-MB-CS Mounting bolts with M12x1 thread adjustable in one axis



TM-APL-CS Air purge collar, laminar



TM-APLCF-CS Air purge collar, laminar with integrated ancillary CF lens



TM-APL-CS Air purge collar, laminar TM-MG-CS Mounting fork



TM-RAM-CS Right angle mirror

Infrared thermal imagers from Micro-Epsilon



thermoIMAGER TIM Compact thermal imaging cameras for industrial temperature monitoring

- Temperature range from -20 °C to 1900 °C
- Ideal for OEM
- Real-time thermography using license-free software
- Protective housing for harsh environments
- Special variants for the glass, metal and plastics industries